

 **FORSAFLEX™**

QUICK DISCONNECTS



www.forsaflex.com

QUICK DISCONNECT TABLE OF CONTENTS

| | Series | Page |
|--|---------------|-------|
| Agricultural Interchange - Sizes 1/4" - 1" | | |
| Agricultural - Poppet | QG-P | 3-4 |
| Agricultural - Ball | QG-B | 5 |
| Agricultural - 3CFHF / 4SRPV | 3CFHF / 4SRPV | 6-7 |
| BOP | | |
| ISO 7241 B - BOP | QB-BOP | 8-9 |
| 75 Series Interchange - BOP | Q75-BOP | 10-11 |
| Flat Face | | |
| ISO 16028 - Sizes 1/4" - 1" | QFF | 12-14 |
| ISO 16028 - Connect Under Pressure - Sizes 3/8" - 3/4" | QFZ | 15-16 |
| Threaded Flat Face - Sizes 1/4" - 2" | QVEP | 17-18 |
| Multifaster - Connection up to 12 Lines | | |
| Skid Steer Manifold/Block | QBD | 19-20 |
| Multifaster | | 21-29 |
| Screw to Connect | | |
| Wing Nut Coupler - Sizes 3/4" - 1-1/2" | QWN / FB | 30-31 |
| 75 Series Interchange - Sizes 3/4" - 2" | Q75 | 32-33 |
| Hydraulic Jack - Sizes 1/4" - 3/8" | QJ | 34-35 |
| Threaded Poppet Valve - Sizes 1/4" - 1" | QV / QVS | 36-38 |
| Special | | |
| Diagonostic - Test Port ISO 15171-1 - Size 1/8" | QTP | 40 |
| H Series Interchange - Sizes 1/4" - 2" | QH | 41-42 |
| Tema Interchange 3/8" - 1" | QTE | 43-44 |
| Standard ISO Series | | |
| ISO A (7241) - Sizes 1/4" - 2" | QA | 45-46 |
| ISO B (7241) - Sizes 1/4" - 2" | QB | 47-49 |
| Water | | |
| Pressure Wash Interchange - Size 1/8" - 2" | QST | 50-52 |
| Water Blast 10,000 PSI - Size 1/2" Non Valved | QWB | 53 |
| Water Blast 15,000 PSI - Size 1/2" Non Valved | QWS | 54 |
| Hydraulic Profiles | | 55-58 |
| Hydraulic Interchange Guide | | 59-66 |

QG Series - Agricultural

Coupler



Single



Push-Pull

Clamp



Nipple



Poppet



Ball

Features

- Poppet valving
- -22°F to +250°F (-30°C to +125°C)
- Single Connection: Sleeve Retraction
- Single Disconnection: Sleeve Retraction
- Single Connection Under Pressure: Not Allowed
- Double Connection: Push
- Double Connection: Pull
- Double Connection Under Pressure: Not Allowed

Applications

- Agricultural
- Industrial
- Mobile Equipment

Interchange

- ISO 5675
- Parker 4000
- Pioneer 4000
- Faster NS/NV
- Stucchi IR
- Safeway S20
- Dixon AG

MAX WORKING PRESSURE - POPPET

| BODY SIZE | (PSI) |
|-----------|-------|
| 1/4" | 5,075 |
| 3/8" | 4,350 |
| 1/2" | 4,350 |
| 3/4" | 4,350 |
| 1" | 3,625 |

MAX WORKING PRESSURE - BALL

| BODY SIZE | (PSI) |
|-----------|-------|
| 1/4" | 3,625 |
| 3/8" | 3,625 |
| 1/2" | 3,000 |

BECAUSE WE CONTINUALLY EXAMINE WAYS TO IMPROVE OUR PRODUCTS, WE RESERVE THE RIGHT TO ALTER SPECIFICATIONS WITHOUT NOTICE.

QG Series - Agricultural - Poppet

SINGLE ACTING SLEEVE (QG)

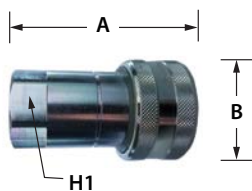

Push-Pull SLEEVE (QGP)

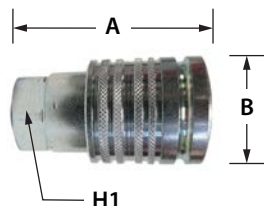

CLAMP FOR DOUBLE ACTING

| CLAMP # | COUPLER # |
|---------|--------------|
| SD12 | QGPC88FP-P |
| SD12 | QGPC88FBSP-P |

COUPLER

| BODY SIZE | THREAD SIZE | STEEL | DIMENSIONS (IN) | | |
|-----------|-------------------------|----------------|-----------------|------|------|
| | | | A | B | H1 |
| 1/4" | 1/4" - Female - NPT | QGC44FP-P | 1.97 | 1.06 | 0.75 |
| 3/8" | 3/8" - Female - NPT | QGC66FP-P | 2.34 | 1.30 | 0.95 |
| 1/2" | 1/2" - Female - NPT | QAC88FP | 2.75 | 1.50 | 1.06 |
| 1/2" | 1/2" - Female - NPT | **QGPC88FP-P | 2.60 | 1.50 | 1.06 |
| 3/4" | 3/4" - Female - NPT | † QGC1212FP-P | 3.27 | 1.89 | 1.34 |
| 3/4" | 3/4" - Female - NPT | QGC1212FP-2 | 3.35 | 1.89 | 1.50 |
| 1" | 1" - Female - NPT | QGC1616FP-P | 3.92 | 2.20 | 1.61 |
| 1/4" | 1/16"-18 - Female - ORB | QGC46FOB-P | 2.07 | 1.06 | 0.75 |
| 3/8" | 3/16"-18 - Female - ORB | QGC66FOB-P | 2.34 | 1.30 | 0.95 |
| 1/2" | 3/4"-16 - Female - ORB | QAC88FOB-P | 2.64 | 1.50 | 1.00 |
| 1/2" | 7/8"-14 - Female - ORB | QAC810FOB-P | 2.75 | 1.50 | 1.25 |
| 1/2" | 1/2" - Female - BSPP | **QGPC88FBSP-P | 2.60 | 1.50 | 1.06 |

** Push-Pull Sleeve † FASTER interchange only

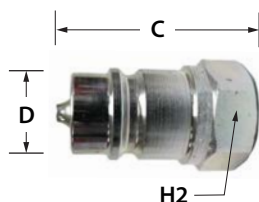

DUST PLUG FOR COUPLER

| BODY SIZE | RUBBER |
|-----------|----------------|
| 1/4" | QG4DP |
| 3/8" | QG6DP |
| 1/2" | QA8DP - Red |
| 1/2" | QA8DP - Black |
| 1/2" | QA8DP - Blue |
| 1/2" | QA8DP - Yellow |
| 3/4" | QG12DP |
| 1" | QG16DP |

NIPPLE

| BODY SIZE | THREAD SIZE | STEEL | DIMENSIONS (in) | | |
|-----------|-------------------------|---------------|-----------------|------|------|
| | | | C | D | H2 |
| 1/4" | 1/4" - Female - NPT | QGN44FP-P | 1.37 | 0.56 | 0.75 |
| 3/8" | 3/8" - Female - NPT | QGN66FP-P | 1.54 | 0.74 | 0.95 |
| 1/2" | 1/2" - Female - NPT | QAN88FP | 1.73 | 0.81 | 1.06 |
| 3/4" | 3/4" - Female - NPT | † QGN1212FP-P | 2.16 | 1.10 | 1.34 |
| 3/4" | 3/4" - Female - NPT | QGN1212FP-2 | 2.20 | 0.93 | 1.38 |
| 1" | 1" - Female - NPT | QGN1616FP-P | 2.60 | 1.23 | 1.61 |
| 1/4" | 1/16"-18 - Female - ORB | QGN46FOB-P | 1.40 | 0.56 | 0.75 |
| 3/8" | 3/16"-18 - Female - ORB | QGN66FOB-P | 1.54 | 0.74 | 0.95 |
| 1/2" | 3/4"-16 - Female - ORB | QAN88FOB-P | 1.73 | 0.81 | 1.06 |
| 1/2" | 7/8"-14 - Female - ORB | QAN810FOB-P | 2.00 | 0.81 | 1.06 |

† FASTER interchange only



DUST CAP FOR NIPPLE

| BODY SIZE | RUBBER |
|-----------|----------------|
| 1/4" | QG4DC |
| 3/8" | QG6DC |
| 1/2" | QA8DC - Red |
| 1/2" | QA8DC - Black |
| 1/2" | QA8DC - Blue |
| 1/2" | QA8DC - Yellow |
| 3/4" | QG12DC |
| 1" | QG16DC |

QG Series - Agricultural - Ball

SINGLE ACTING SLEEVE (QG)

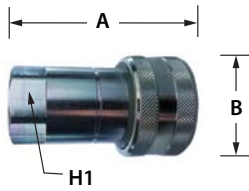

Push-Pull SLEEVE (QGP)

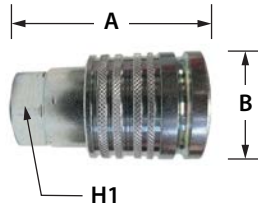

COUPLER

| BODY SIZE | THREAD SIZE | STEEL | DIMENSIONS (IN) | | |
|-----------|---------------------|---------------|-----------------|------|------|
| | | | A | B | H1 |
| 1/4" | 1/4" - Female - NPT | QGC44FP-B | 1.97 | 1.06 | 0.75 |
| 3/8" | 3/8" - Female - NPT | QGC66FP-B | 2.34 | 1.30 | 0.95 |
| 1/2" | 1/2" - Female - NPT | QGC88FP-B | 2.60 | 1.50 | 1.06 |
| 1/2" | 1/2" - Female - NPT | ** QGPC88FP-B | 2.68 | 1.50 | 1.06 |

** Push-Pull Sleeve

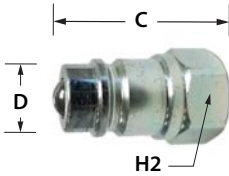

NIPPLE

| BODY SIZE | THREAD SIZE | STEEL | DIMENSIONS (IN) | | |
|-----------|---------------------|--------------|-----------------|------|------|
| | | | C | D | H2 |
| 1/4" | 1/4" - Female - NPT | QGN44FP-B | 1.30 | 0.56 | 0.75 |
| 3/8" | 3/8" - Female - NPT | QGN66FP-B | 1.54 | 0.74 | 0.95 |
| 1/2" | 1/2" - Female - NPT | QGN88FP-B | 1.81 | 0.81 | 1.06 |
| 1/2" | 1/2" - Female - NPT | QGN88FP-B-ZN | 1.81 | 0.81 | 1.06 |

ZN = Zinc nickel plating



CLAMP FOR DOUBLE ACTING

| CLAMP # | COUPLER # |
|---------|------------|
| SD12 | QGPC88FP-B |



DUST PLUG - COUPLER

| BODY SIZE | RUBBER |
|-----------|----------------|
| 1/4" | QG4DP |
| 3/8" | QG6DP |
| 1/2" | QA8DP |
| 1/2" | QG8DP - Red |
| 1/2" | QG8DP - Black |
| 1/2" | QG8DP - Blue |
| 1/2" | QG8DP - Yellow |



Dust Cap for Nipple

| BODY SIZE | RUBBER |
|-----------|----------------|
| 1/4" | QG4DC |
| 3/8" | QG6DC |
| 1/2" | QA8DC |
| 1/2" | QG8DC - Red |
| 1/2" | QG8DC - Black |
| 1/2" | QG8DC - Blue |
| 1/2" | QG8DC - Yellow |

BECAUSE WE CONTINUALLY EXAMINE WAYS TO IMPROVE OUR PRODUCTS, WE RESERVE THE RIGHT TO ALTER SPECIFICATIONS WITHOUT NOTICE.

3CFHF / 4SRPV - Agricultural

Coupler



3CFHF

Connect under Pressure
Nipple Side Only



4SRPV

Connect under Pressure
both Nipple & Coupler Sides

Nipple



Poppet

Features

- Poppet valving
- Nitrite seals / PTFE backup ring
- -22°F to +250°F (-30°C to +125°C)
- Connection: Push
- Connection: Pull
- Connection Under Pressure: Allowed 50% of WP

BECAUSE WE CONTINUALLY EXAMINE WAYS TO IMPROVE OUR PRODUCTS, WE RESERVE THE RIGHT TO ALTER SPECIFICATIONS WITHOUT NOTICE.

3CFHF / 4SRPV - Agricultural

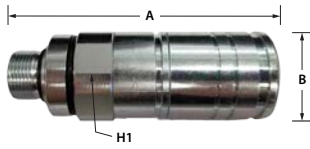

COUPLER - 3CFHF

| BODY SIZE | THREAD SIZE | STEEL | DIMENSIONS (IN) | | |
|-----------|---------------------|-----------------|-----------------|------|------|
| | | | A | B | H1 |
| 1/2" | 1/2" - Female - NPT | 3CFHF-12NPT-F | 4.22 | 1.65 | 1.06 |
| 1/2" | - 8 - Female - ORB | 3CFHF-34UNF-F | 4.22 | 1.65 | 1.06 |
| 1/2" | - 10 - Male - ORB | 3CFHF1/78UNF-F | 4.27 | 1.65 | 1.26 |
| 1/2" | - 10 - Male - JIC | 3CFHF14/78UNF-F | 4.26 | 1.65 | 1.26 |
| 1/2" | - 10 - Bulk - ORFS | 3CFHF12/IUNS-F | 5.13 | 1.65 | 1.26 |
| 1/2" | M22 x 1.5 - Male | 3CFHF1/2215FJDC | 4.36 | 1.65 | 1.50 |

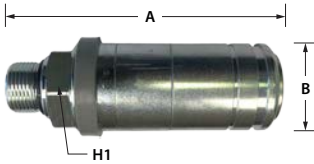

COUPLER - 4SRPV

| BODY SIZE | THREAD SIZE | STEEL | DIMENSIONS (IN) | | |
|-----------|---------------------|----------------|-----------------|------|------|
| | | | A | B | H1 |
| 1/2" | 1/2" - Female - NPT | 4SRPV0812N-FH | 4.3 | 1.65 | 1.06 |
| 1/2" | - 8 - Female - ORB | 4SRPV0812S-FH | 4.3 | 1.65 | 1.06 |
| 1/2" | M22 x 1.5 - Male | 4SRPV081/22-FH | 4.42 | 1.65 | 1.25 |

BECAUSE WE CONTINUALLY EXAMINE WAYS TO IMPROVE OUR PRODUCTS, WE RESERVE THE RIGHT TO ALTER SPECIFICATIONS WITHOUT NOTICE.

QB Series - BOP

Coupler



Nipple



Features

- Poppet valve
- FKM seals / PTFE Back-up ring
- -Up to 1,300°F (700°C) as per API 16D
- Connection: Sleeve Retraction
- Disconnection: Sleeve Retraction
- Connect under pressure: Not Allowed

Applications

- Oil & Gas
- Blow-out preventer systems

Interchange

- ISO 7241 - B (BOP)
- Faster HNVFR
- Dixon H - BOP
- Snap-Tite 72
- Eaton HKFR

MAX WORKING PRESSURE (PSI)

| BODY SIZE | STEEL |
|-----------|-------|
| 3/8" | 4,350 |
| 1/2" | 5,000 |
| 3/4" | 3,625 |
| 1" | 4,350 |

BECAUSE WE CONTINUALLY EXAMINE WAYS TO IMPROVE OUR PRODUCTS, WE RESERVE THE RIGHT TO ALTER SPECIFICATIONS WITHOUT NOTICE.

QB Series - BOP

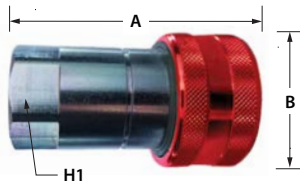

COUPLER

| BODY SIZE | THREAD SIZE | STEEL | DIMENSIONS (IN) | | |
|-----------|---------------------|---------------|-----------------|------|------|
| | | | A | B | H1 |
| 3/8" | 3/8" - Female - NPT | QBC66FP-BOP | 2.62 | 1.34 | 0.94 |
| 1/2" | 1/2" - Female - NPT | QBC88FP-BOP | 2.91 | 1.62 | 1.18 |
| 3/4" | 3/4" - Female - NPT | QBC1212FP-BOP | 3.58 | 2.01 | 1.42 |
| 1" | 1" - Female - NPT | QBC1616FP-BOP | 4.10 | 2.33 | 1.61 |

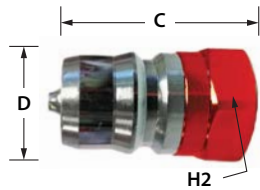

NIPPLE

| BODY SIZE | THREAD SIZE | STEEL | DIMENSIONS (IN) | | |
|-----------|---------------------|---------------|-----------------|------|------|
| | | | C | D | H2 |
| 3/8" | 3/8" - Female - NPT | QBN66FP-BOP | 1.85 | 0.76 | 0.86 |
| 1/2" | 1/2" - Female - NPT | QBN88FP-BOP | 2.06 | 0.92 | 1.06 |
| 3/4" | 3/4" - Female - NPT | QBN1212FP-BOP | 2.54 | 1.26 | 1.33 |
| 1" | 1" - Female - NPT | QBN1616FP-BOP | 2.86 | 1.48 | 1.61 |

BECAUSE WE CONTINUALLY EXAMINE WAYS TO IMPROVE OUR PRODUCTS, WE RESERVE THE RIGHT TO ALTER SPECIFICATIONS WITHOUT NOTICE.

Q75 Series - BOP

Coupler



Nipple



Features

- Poppet valve
- FKM / PTFE Back-up ring
- Connection: Screw to Connect
- Disconnection: Unscrew to Disconnect
- Connect under pressure: Allowed Residual

Applications

- Oil & Gas
- Blow-out preventer systems

Interchange

- Faster OGVFR
- Snap-Tite 75
- Dixon WS - BOP

2

BOP

MAX WORKING PRESSURE (PSI)

| BODY SIZE | STEEL |
|-----------|-------|
| ¾" | 5,000 |
| 1" | 5,000 |
| 1-¼" | 5,000 |
| 1-½" | 5,000 |
| 2" | 5,000 |

BECAUSE WE CONTINUALLY EXAMINE WAYS TO IMPROVE OUR PRODUCTS, WE RESERVE THE RIGHT TO ALTER SPECIFICATIONS WITHOUT NOTICE.

Q75 Series - BOP

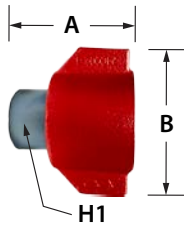

COUPLER

| BODY SIZE | THREAD SIZE | STEEL | DIMENSIONS (IN) | | |
|-----------|---------------------|------------------|-----------------|------|------|
| | | | A | B | H1 |
| ¾" | ¾" - Female - NPT | Q75C1212FP - BOP | 2.84 | 2.17 | 1.26 |
| 1" | 1" - Female - NPT | Q75C1616FP - BOP | 3.45 | 4.15 | 1.61 |
| 1-¼" | 1-¼" - Female - NPT | Q75C2020FP - BOP | 4.41 | 4.65 | 1.97 |



DUST CAP FOR COUPLER

| BODY SIZE | METAL |
|-----------|---------|
| ¾" | Q7512DP |
| 1" | Q7516DP |
| 1-¼" | Q7520DP |

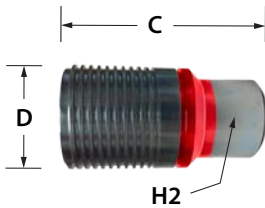

NIPPLE

| BODY SIZE | THREAD SIZE | STEEL | DIMENSIONS (IN) | | |
|-----------|---------------------|------------------|-----------------|------|------|
| | | | C | D | H2 |
| ¾" | ¾" - Female - NPT | Q75N1212FP - BOP | 3.27 | 1.74 | 1.26 |
| 1" | 1" - Female - NPT | Q75N1616FP - BOP | 4.17 | 2.25 | 1.61 |
| 1-¼" | 1-¼" - Female - NPT | Q75N2020FP - BOP | 5.37 | 2.62 | 1.47 |



DUST CAP FOR NIPPLE

| BODY SIZE | METAL |
|-----------|---------|
| ¾" | Q7512DC |
| 1" | Q7516DC |
| 1-¼" | Q7520DC |

BECAUSE WE CONTINUALLY EXAMINE WAYS TO IMPROVE OUR PRODUCTS, WE RESERVE THE RIGHT TO ALTER SPECIFICATIONS WITHOUT NOTICE.

QFF Series - Flat Face

Coupler



Nipple



Features

- Flat face valve
- No spillage
- Zinc Nickel Plating
- -22°F to +250°F (-30°C to +125°C)
- Connection: Push to Connect
- Disconnection: Sleeve Retraction
- Connection Under Pressure: Not Allowed

Applications

- Skid steer loaders
- Public Utility - lift truck
- Agricultural
- Industrial
- Mobile Equipment
- Oil & Gas

Interchange

- ISO 16028
- Parker FEM
- Eaton FD89
- Faster FFH
- Stucchi FIRG
- Dixon HT
- Snap-Tite 74
- Safeway FF49

MAX WORKING PRESSURE (PSI)

| BODY SIZE | STEEL |
|-----------|-------|
| 1/4 | 5,000 |
| 3/8 | 5,000 |
| 1/2 | 5,000 |
| 3/4 | 5,000 |
| 1 | 5,000 |

BECAUSE WE CONTINUALLY EXAMINE WAYS TO IMPROVE OUR PRODUCTS, WE RESERVE THE RIGHT TO ALTER SPECIFICATIONS WITHOUT NOTICE.

QFF Series - Flat Face

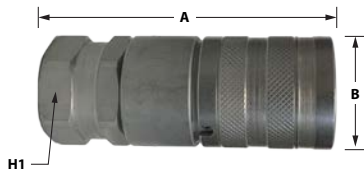

COUPLER

| BODY SIZE | THREAD SIZE | STEEL | DIMENSIONS (IN) | | |
|-----------|-----------------------------|-------------|-----------------|------|------|
| | | | A | B | H1 |
| 1/4" | 1/4" - Female - NPT | QFFC44FP | 2.31 | 1.06 | 0.95 |
| 3/8" | 3/8" - Female - NPT | QFFC66FP | 2.95 | 1.18 | 1.06 |
| 3/8" | 1/2" - Female - NPT | QFFC68FP | 3.13 | 1.18 | 1.06 |
| 1/2" | 1/2" - Female - NPT | QFFC88FP | 3.20 | 1.50 | 1.34 |
| 1/2" | 3/4" - Female - NPT | QFFC812FP | 3.20 | 1.50 | 1.34 |
| 5/8" | 3/4" - Female - NPT | QFFC1012FP | 3.63 | 1.65 | 1.50 |
| 3/4" | 3/4" - Female - NPT | QFFC1212FP | 4.11 | 1.89 | 1.65 |
| 3/4" | 1" - Female - NPT | QFFC1216FP | 4.11 | 1.89 | 1.65 |
| 1" | 1" - Female - NPT | QFFC1616FP | 3.96 | 2.16 | 1.97 |
| 1/4" | 9/16" - 18 - Female - ORB | QFFC46FOB | 2.35 | 1.06 | 0.95 |
| 3/8" | 9/16" - 18 - Female - ORB | QFFC66FOB | 2.30 | 1.18 | |
| 3/8" | 3/4" - 16 - Female - ORB | QFFC68FOB | 3.03 | 1.18 | 1.06 |
| 1/2" | 3/4" - 16 - Female - ORB | QFFC88FOB | 3.20 | 1.50 | 1.34 |
| 1/2" | 7/8" - 14 - Female - ORB | QFFC810FOB | 3.20 | 1.50 | 1.34 |
| 1/2" | 1-1/16" - 12 - Female - ORB | QFFC812FOB | 3.42 | 1.50 | 1.34 |
| 5/8" | 1-1/16" - 12 - Female - ORB | QFFC1012FOB | 3.76 | 1.65 | 1.50 |
| 3/4" | 1-1/16" - 12 - Female - ORB | QFFC1212FOB | 4.11 | 1.89 | 1.65 |
| 3/4" | 1-5/16" - 12 - Female - ORB | QFFC1216FOB | 4.11 | 1.89 | 1.65 |
| 1" | 1-5/16" - 12 - Female - ORB | QFFC1616FOB | 3.96 | 2.16 | 1.97 |
| 1/2" | 13/16" - 16 - BH - ORFS | QFFC88MFB | 4.17 | 1.50 | 1.06 |
| 1/2" | 1" - 14 - BH - ORFS | QFFC810MFB | 4.40 | 1.50 | 1.34 |
| 1/2" | 1-3/16" - 12 - BH - ORFS | QFFC812MFB | 4.44 | 1.50 | 1.34 |
| 3/4" | 1-3/16" - 12 - BH - ORFS | QFFC1212MFB | 5.34 | 1.89 | 1.65 |
| 3/8" | 3/4" - 16 - BH - JIC | QFFC68MJB | 4.19 | 1.18 | 1.06 |
| 1/2" | 3/4" - 16 - BH - JIC | QFFC88MJB | 4.32 | 1.50 | 1.34 |
| 1/2" | 7/8" - 14 - BH - JIC | QFFC810MJB | 4.39 | 1.50 | 1.34 |
| 1/2" | 1-1/16" - 12 - BH - JIC | QFFC812MJB | 4.56 | 1.50 | 1.34 |
| 3/4" | 1-1/16" - 12 - BH - JIC | QFFC1212MJB | 5.37 | 1.89 | 1.65 |

DUST CAP FOR COUPLER

| BODY SIZE | RUBBER |
|-----------|---------|
| 1/4" | QFF4DP |
| 3/8" | QFF6DP |
| 1/2" | QFF8DP |
| 5/8" | QFF10DP |
| 3/4" | QFF12DP |
| 1" | QFF16DP |

BECAUSE WE CONTINUALLY EXAMINE WAYS TO IMPROVE OUR PRODUCTS, WE RESERVE THE RIGHT TO ALTER SPECIFICATIONS WITHOUT NOTICE.

QFF Series - Flat Face



NIPPLE

| BODY SIZE | THREAD SIZE | STEEL | DIMENSIONS (IN) | | |
|-----------|-----------------------------|-------------|-----------------|------|------|
| | | | C | D | H2 |
| 1/4" | 1/4" - Female - NPTF | QFFN44FP | 1.93 | 0.63 | 0.94 |
| 3/8" | 3/8" - Female - NPTF | QFFN66FP | 2.69 | 0.78 | 1.18 |
| 3/8" | 1/2" - Female - NPTF | QFFN68FP | 2.83 | 0.78 | 1.18 |
| 1/2" | 1/2" - Female - NPTF | QFFN88FP | 3.03 | 0.96 | 1.34 |
| 1/2" | 3/4" - Female - NPTF | QFFN812FP | 3.03 | 0.96 | 1.34 |
| 5/8" | 3/4" - Female - NPTF | QFFN1012FP | 3.59 | 1.06 | 1.61 |
| 3/4" | 3/4" - Female - NPTF | QFFN1212FP | 4.00 | 1.18 | 1.65 |
| 3/4" | 1" - Female - NPTF | QFFN1216FP | 4.00 | 1.18 | 1.65 |
| 1" | 1" - Female - NPTF | QFFN1616FP | 4.23 | 1.42 | 2.17 |
| 1" | 1-1/4" - 12 - Female - NPTF | QFFN1620FP | 4.30 | 1.42 | 2.17 |
| 1/4" | 9/16" - 18 - Female - ORB | QFFN46FOB | 2.05 | 0.63 | 0.94 |
| 3/8" | 9/16" - 18 - Female - ORB | QFFN66FOB | 2.83 | 0.78 | 1.18 |
| 3/8" | 3/4" - 16 - Female - ORB | QFFN68FOB | 2.83 | 0.78 | 1.18 |
| 1/2" | 3/4" - 16 - Female - ORB | QFFN88FOB | 2.95 | 0.96 | 1.34 |
| 1/2" | 7/8" - 14 - Female - ORB | QFFN810FOB | 2.99 | 0.96 | 1.34 |
| 1/2" | 1-1/16" - 12 - Female - ORB | QFFN812FOB | 3.19 | 0.96 | 1.34 |
| 5/8" | 1-1/16" - 12 - Female - ORB | QFFN1012FOB | 3.57 | 1.06 | 1.61 |
| 3/4" | 1-1/16" - 12 - Female - ORB | QFFN1212FOB | 4.00 | 1.18 | 1.65 |
| 3/4" | 1-5/16" - 12 - Female - ORB | QFFN1216FOB | 4.00 | 1.18 | 1.65 |
| 1" | 1-5/16" - 12 - Female - ORB | QFFN1616FOB | 4.19 | 1.42 | 2.17 |
| 1/2" | 1" - 14 - BH - ORFS | QFFN810MFB | 4.10 | 0.96 | 1.34 |
| 1/2" | 1-3/16" - 12 - BH - ORFS | QFFN812MFB | 3.94 | 0.96 | 1.34 |
| 1/2" | 1-7/16" - BH - ORFS | QFFC816MFB | 4.80 | 1.42 | 1.49 |
| 3/4" | 1-3/16" - 12 - BH - ORFS | QFFN1212MFB | 5.10 | 1.18 | 1.65 |
| 3/8" | 3/4" - 16 - BH - JIC | QFFN68MJB | 3.85 | 0.78 | 1.18 |
| 1/2" | 7/8" - 14 - BH - JIC | QFFN810MJB | 4.08 | 0.96 | 1.34 |
| 1/2" | 1-1/16" - 12 - BH - JIC | QFFN812MJB | 4.27 | 0.96 | 1.34 |
| 3/4" | 1-1/16" - 12 - BH - JIC | QFFN1212MJB | 5.13 | 1.18 | 1.65 |

DUST CAP FOR NIPPLE

| BODY SIZE | RUBBER |
|-----------|---------|
| 1/4" | QFF4DC |
| 3/8" | QFF6DC |
| 1/2" | QFF8DC |
| 5/8" | QFF10DC |
| 3/4" | QFF12DC |
| 1" | QFF16DC |

QFZ Series - Connect Under Pressure - Flat Face

Coupler



Nipple



Features

- Easy to clean flat surfaces
- Nickel plating
- -22°F to +212°F (-30°C to +100°C)
- Connection: Push to Connect
- Disconnection: Sleeve Retraction
- Connection Under Pressure: Allowed to 50% of M.W.P.

Applications

- Construction
- Skid steer equipment
- Public Utility - Lift Trucks
- Municipalities - Plows

Interchange

- ISO 16028
- Parker FC
- Faster 3FFH
- Stucchi
- CEJN 264
- Dixon HTZ

MAX WORKING PRESSURE (PSI)

| BODY SIZE | STEEL |
|-----------|-------|
| 3/8" | 5,000 |
| 1/2" | 5,000 |
| 5/8" | 5,000 |
| 3/4" | 5,000 |

BECAUSE WE CONTINUALLY EXAMINE WAYS TO IMPROVE OUR PRODUCTS, WE RESERVE THE RIGHT TO ALTER SPECIFICATIONS WITHOUT NOTICE.

QFZ Series - Connect Under Pressure - Flat Face



COUPLER - FEMALE

| BODY SIZE | THREAD SIZE | STEEL | DIMENSIONS (IN) | | |
|-----------|-----------------------------|------------|-----------------|------|------|
| | | | A | B | H1 |
| 3/8" | 1/2" - Female - NPT | QFZC68FP | 3.13 | 1.18 | 1.06 |
| 1/2" | 1/2" - Female - NPT | QFZC88FP | 3.20 | 1.50 | 1.34 |
| 1/2" | 7/8" - 14 - Female - ORB | QFZC810FOB | 3.20 | 1.50 | 1.34 |
| 1/2" | 1-1/16" - 12 - Female - ORB | QFZC812FOB | 3.97 | 1.50 | 1.34 |



DUST CAP FOR COUPLER

| BODY SIZE | RUBBER |
|-----------|---------|
| 1/4" | QFF4DP |
| 3/8" | QFF6DP |
| 1/2" | QFF8DP |
| 5/8" | QFF10DP |
| 3/4" | QFF12DP |
| 1" | QFF16DP |

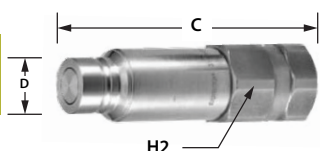

NIPPLE - FEMALE

| BODY SIZE | THREAD SIZE | STEEL | DIMENSIONS (IN) | | |
|-----------|---------------------------|-------------|-----------------|------|------|
| | | | C | D | H2 |
| 3/8" | 3/8" - Female - NPT | QFZN66FP | 3.81 | 0.78 | 1.18 |
| 1/2" | 1/2" - Female - NPT | QFZN88FP | 4.63 | 0.96 | 1.34 |
| 1/2" | 3/4" - Female - NPT | QFZN812FP | 4.92 | 0.96 | 1.61 |
| 5/8" | 3/4" - Female - NPT | QFZN1012FP | 4.97 | 1.06 | 1.61 |
| 3/4" | 3/4" - Female - NPT | QFZN1212FP | 5.06 | 1.18 | 1.65 |
| 1" | 1" - Female - NPT | QFZN1616FP | 5.82 | 1.47 | 1.97 |
| 3/8" | 3/4"-16 - Female - ORB | QFZN68FOB | 3.95 | 0.78 | 0.18 |
| 1/2" | 3/4"-16 - Female - ORB | QFZN88FOB | 4.56 | 0.96 | 1.34 |
| 1/2" | 7/8"-14 - Female - ORB | QFZN810FOB | 4.59 | 0.96 | 1.34 |
| 1/2" | 1-1/16"-12 - Female - ORB | QFZN812FOB | 4.79 | 0.96 | 1.34 |
| 5/8" | 1-1/16"-12 - Female - ORB | QFZN1012FOB | 4.99 | 1.06 | 1.61 |
| 3/4" | 1-1/16"-12 - Female - ORB | QFZN1212FOB | 5.06 | 1.18 | 1.65 |
| 1/2" | 1" - 14 - Male - ORFS | QFZN810MFB | 5.70 | 1.46 | 1.34 |
| 1/2" | 1" - 3/16 - Male - ORFS | QFZN812MFB | 5.95 | 1.46 | 1.34 |



DUST CAP FOR NIPPLE

| BODY SIZE | ALUMINUM |
|-----------|----------|
| 1/4" | QFF4DC |
| 3/8" | QFF6DC |
| 1/2" | QFF8DC |
| 5/8" | QFF10DC |
| 1" | QFF16DC |

BECAUSE WE CONTINUALLY EXAMINE WAYS TO IMPROVE OUR PRODUCTS, WE RESERVE THE RIGHT TO ALTER SPECIFICATIONS WITHOUT NOTICE.

QVEP Series - Threaded Flat Face

Coupler



Nipple



Features

- Flat face valve
- Low connection force
- Connection: Screw to Connect
- Disconnection: Unscrew to Disconnect
- Connect Under Pressure: Allow to 1/2 W.P.

Applications

- Drilling rigs
- Oilfield, well head drives, & tongs
- Cranes
- Hammers
- Trenching equipment
- Excavators

Interchange

- Stucchi VEP
- Parker FET
- Dixon VEP

MAX WORKING PRESSURE (PSI)

| BODY SIZE | STEEL |
|-----------|-------|
| 3/8" | 5,500 |
| 1/2" | 5,500 |
| 3/4" | 5,500 |
| 1" | 5,000 |
| 1-1/4" | 5,100 |
| 1-1/2" | 4,500 |



Correct procedure to connect and disconnect the QVEP series

1. Clean all mating surfaces thoroughly, then pull coupler sleeve forward.
2. Align coupler and nipple, pushing/turning the coupler sleeve towards the nipple while engaging the threads.
Allow threads to pull coupler into the nipple.
3. Initial connection should be hand threaded, followed by a wrench.
4. Continue to thread coupler sleeve into nipple until end of sleeve meets nipple body.
5. To disconnect, use a wrench to break sleeve free and keep coupler and nipple aligned.

BECAUSE WE CONTINUALLY EXAMINE WAYS TO IMPROVE OUR PRODUCTS, WE RESERVE THE RIGHT TO ALTER SPECIFICATIONS WITHOUT NOTICE.

QVEP Series - Threaded Flat Face

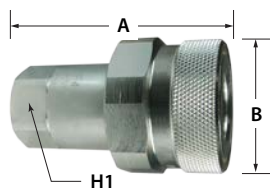

COUPLER - FEMALE

| BODY SIZE | THREAD SIZE | STEEL | DIMENSIONS (IN) | | |
|-----------|---------------------------|--------------|-----------------|------|------|
| | | | A | B | H1 |
| 3/8" | 3/8" - Female - NPTF | QVEPC66FP | 2.55 | 1.62 | 1.00 |
| 1/2" | 1/2" - Female - NPTF | QVEPC88FP | 3.08 | 1.98 | 1.18 |
| 3/4" | 3/4" - Female - NPTF | QVEPC1212FP | 3.37 | 2.19 | 1.50 |
| 1" | 1" - Female - NPTF | QVEPC1616FP | 3.89 | 2.46 | 1.73 |
| 1-1/4" | 1-1/4" - Female - NPTF | QVEPC2020FP | 4.40 | 2.70 | 2.17 |
| 1-1/2" | 1-1/2" - Female - NPTF | QVEPC2424FP | 5.28 | 3.74 | 2.48 |
| 3/8" | 3/4"-16 - Female - ORB | QVEPC68FOB | 2.77 | 1.62 | 1.00 |
| 1/2" | 3/4"-16 - Female - ORB | QVEPC88FOB | 3.08 | 1.98 | 1.18 |
| 3/4" | 1-1/16"-12 - Female - ORB | QVEPC1212FOB | 3.37 | 2.19 | 1.50 |
| 1" | 1-5/16"-12 - Female - ORB | QVEPC1616FOB | 3.89 | 2.46 | 1.73 |
| 1-1/4" | 1-5/8"-12 - Female - ORB | QVEPC2020FOB | 4.40 | 2.70 | 2.17 |
| 1-1/2" | 1-7/8"-12 - Female - ORB | QVEPC2424FOB | 5.28 | 3.74 | 2.48 |



DUST PLUG

| BODY SIZE | METAL |
|-----------|----------|
| 3/8" | QVEP6DP |
| 1/2" | QVEP8DP |
| 3/4" | QVEP12DP |
| 1" | QVEP16DP |
| 1-1/4" | QVEP20DP |
| 1-1/2" | QVEP24DP |

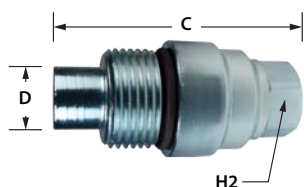

NIPPLE - FEMALE

| BODY SIZE | THREAD SIZE | STEEL | DIMENSIONS (IN) | | |
|-----------|---------------------------|--------------|-----------------|-------|------|
| | | | C | D | H2 |
| 3/8" | 3/8" - Female - NPT | QVEPN66FP | 3.28 | 0.78 | 1.00 |
| 1/2" | 1/2" - Female - NPT | QVEPN88FP | 3.87 | 0.96 | 1.18 |
| 3/4" | 3/4" - Female - NPT | QVEPN1212FP | 4.12 | 1.062 | 1.50 |
| 1" | 1" - Female - NPT | QVEPN1616FP | 4.95 | 1.18 | 1.73 |
| 1-1/4" | 1-1/4" - Female - NPT | QVEPN2020FP | 5.43 | 1.44 | 2.16 |
| 1-1/2" | 1-1/2" - Female - NPT | QVEPN2424FP | 6.63 | 2.25 | 2.48 |
| 3/8" | 3/4"-16 - Female - ORB | QVEPN68FOB | 3.50 | 0.78 | 1.00 |
| 1/2" | 3/4"-16 - Female - ORB | QVEPN88FOB | 3.87 | 0.96 | 1.18 |
| 3/4" | 1-1/16"-12 - Female - ORB | QVEPN1212FOB | 4.12 | 1.062 | 1.50 |
| 1" | 1-5/16"-12 - Female - ORB | QVEPN1616FOB | 4.95 | 1.18 | 1.73 |
| 1-1/4" | 1-5/8"-12 - Female - ORB | QVEPN2020FOB | 5.43 | 1.44 | 2.17 |
| 1-1/2" | 1-7/8"-12 - Female - ORB | QVEPN2424FOB | 6.63 | 2.25 | 2.48 |



DUST CAP

| BODY SIZE | METAL |
|-----------|----------|
| 3/8" | QVEP6DC |
| 1/2" | QVEP8DC |
| 3/4" | QVEP12DC |
| 1" | QVEP16DC |
| 1-1/4" | QVEP20DC |
| 1-1/2" | QVEP24DC |

BECAUSE WE CONTINUALLY EXAMINE WAYS TO IMPROVE OUR PRODUCTS, WE RESERVE THE RIGHT TO ALTER SPECIFICATIONS WITHOUT NOTICE.

QBD Series - Block Valve

Block Valve



New

Old

Cartridge Nipple



New

Old

Cartridge Coupler



New

Old

Features

- Flat face valve
- No spillage
- -22°F to +250°F (-30°C to +123°C)
- Connection: Push to Connect
- Disconnection: Sleeve Retraction

Applications

- Skid steer equipment
- Tractors
- Municipalities - Plows

Interchange

- ISO 16028
- Faster

MAX WORKING PRESSURE (PSI)

| BODY SIZE | STEEL |
|-----------|-------|
| 1/2" | 5,075 |
| 3/4" | 5,075 |

BECAUSE WE CONTINUALLY EXAMINE WAYS TO IMPROVE OUR PRODUCTS, WE RESERVE THE RIGHT TO ALTER SPECIFICATIONS WITHOUT NOTICE.

QBD Series - Block Valve



BLOCK VALVE - NEW

| BODY | PART NO. | CROSSOVER NO. | DESCRIPTION | BOX |
|-------------------|-----------|-----------------|--|-----|
| 1/2" | QBD810FOB | 4BD4FH08-58SAE | 1/2" NEW BLOCK VALVE X -10 FOB | 1 |
| 1/2" | QBD812MJ | 4BD4FH08-13/34S | 1/2" NEW BLOCK VALVE X -12 MALE JIC | 1 |
| 3/4" | QBD1212MJ | 4BD4FH12-13/34S | 3/4" NEW BLOCK VALVE X -12 MALE JIC | 1 |
| SPARE PARTS - NEW | | | | |
| 3/8" | QBDN6 | KIT-4BD-FFH06M | 3/8" CARTRIDGE NIPPLE - NEW/OLD | 20 |
| 1/2" | QBDN8-N | KIT-4FH08-M | 1/2" CARTRIDGE NIPPLE - NEW BLOCK VALVE | 6 |
| 3/4" | QBDN12-N | KIT-4FH12-M | 3/4" CARTRIDGE NIPPLE - NEW BLOCK VALVE | 4 |
| 1/2" | QBDC8-N | KIT-4FH08-F | 1/2" CARTRIDGE COUPLER - NEW BLOCK VALVE | 6 |
| 3/4" | QBDC12-N | KIT-4FH12-F | 3/4" CARTRIDGE COUPLER - NEW BLOCK VALVE | 4 |
| 3/4" | QBD12SK-N | -- | NEW BLOCK VALVE - SEAL KIT | 10 |



BLOCK VALVE - OLD

| BODY | PART NO. | CROSSOVER NO. | DESCRIPTION | BOX |
|-------------------|--------------|-----------------|---|-----|
| 1/2" | QBD812MJ-OLD | 4BD4FI12-13/34S | 1/2" OLD BLOCK VALVE X -12MALE JIC | 1 |
| SPARE PARTS - OLD | | | | |
| 3/8" | QBDN6 | KIT-4BD-FFH06M | 3/8" CARTRIDGE NIPPLE - NEW/OLD | 20 |
| 1/2" | QBDN8 | KIT-4FI12-M | 1/2" CARTRIDGE NIPPLE - OLD BLOCK VALVE | 10 |
| 1/2" | QBDC8 | KIT-4FI12- F | 1/2" CARTRIDGE COUPLER - OLD BLOCK VALVE | 10 |
| 1/2" | QBDC8-K | KIT-4FS12-F | 1/2" CARTRIDGE KIDNEY COUPLER - OLD BLOCK VALVE | 10 |
| 1/2" | QBD8SK | KIT-4FI12-OR | OLD BLOCK VALVE - SEAL KIT | 25 |



90 ELBOW - FLAT FACE

| BODY | PART NO. | CROSSOVER NO. | DESCRIPTION | BOX |
|------|------------|-----------------|---|-----|
| 1/2" | QFFN812-90 | FFH08-61/34S M | 90 DEG ELBOW FF 1/2" NIPPLE X -12 MALE JIC | 5 |
| 1/2" | QFFN86-90 | FFH08-61/38S M | 90 DEG ELBOW FF 1/2" NIPPLE X - 6 MALE JIC | 5 |
| 1/2" | QFZC812-90 | 3FFH08-61/34SFS | UNDER PRESS 90 DEG FF 1/2" COUPLER X -12 MJIC | 5 |
| 1/2" | QFZC86-90 | 3FFH08-61/38SFS | UNDER PRESS 90 DEG FF 1/2" COUPLER X - 6 MJIC | 5 |



BECAUSE WE CONTINUALLY EXAMINE WAYS TO IMPROVE OUR PRODUCTS, WE RESERVE THE RIGHT TO ALTER SPECIFICATIONS WITHOUT NOTICE.

Multifaster

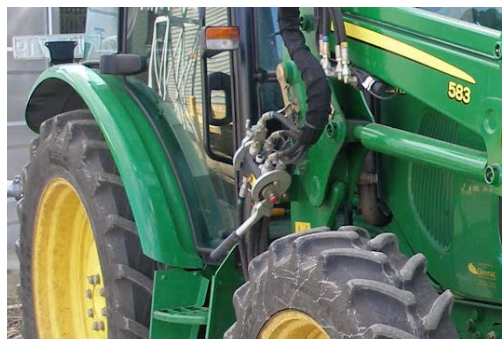

Features

- Simultaneous connection of multiple lines
- No risk of line misalignment due to reference pins on fixed half
- Flat face couplers offer no spillage or air inclusion upon connection
- Ease of cleaning due to face design
- Connect Under Pressure - 2P Residual Pressure
- Connect Under Pressure - 3P 3,625 PSI
- -22°F to +250°F (-30°F to +121°C)

Applications

- Front end loaders
- Construction machinery
- Harvesting equipment

Interchange

- Faster

MAX WORKING PRESSURE (PSI)

| BODY SIZE | 2P | 3P |
|-----------|-------|-------|
| 3/8" | 3,625 | 3,625 |
| 1/2" | 3,625 | 3,625 |

BECAUSE WE CONTINUALLY EXAMINE WAYS TO IMPROVE OUR PRODUCTS, WE RESERVE THE RIGHT TO ALTER SPECIFICATIONS WITHOUT NOTICE.

Multifaster - Part Number Breakdown

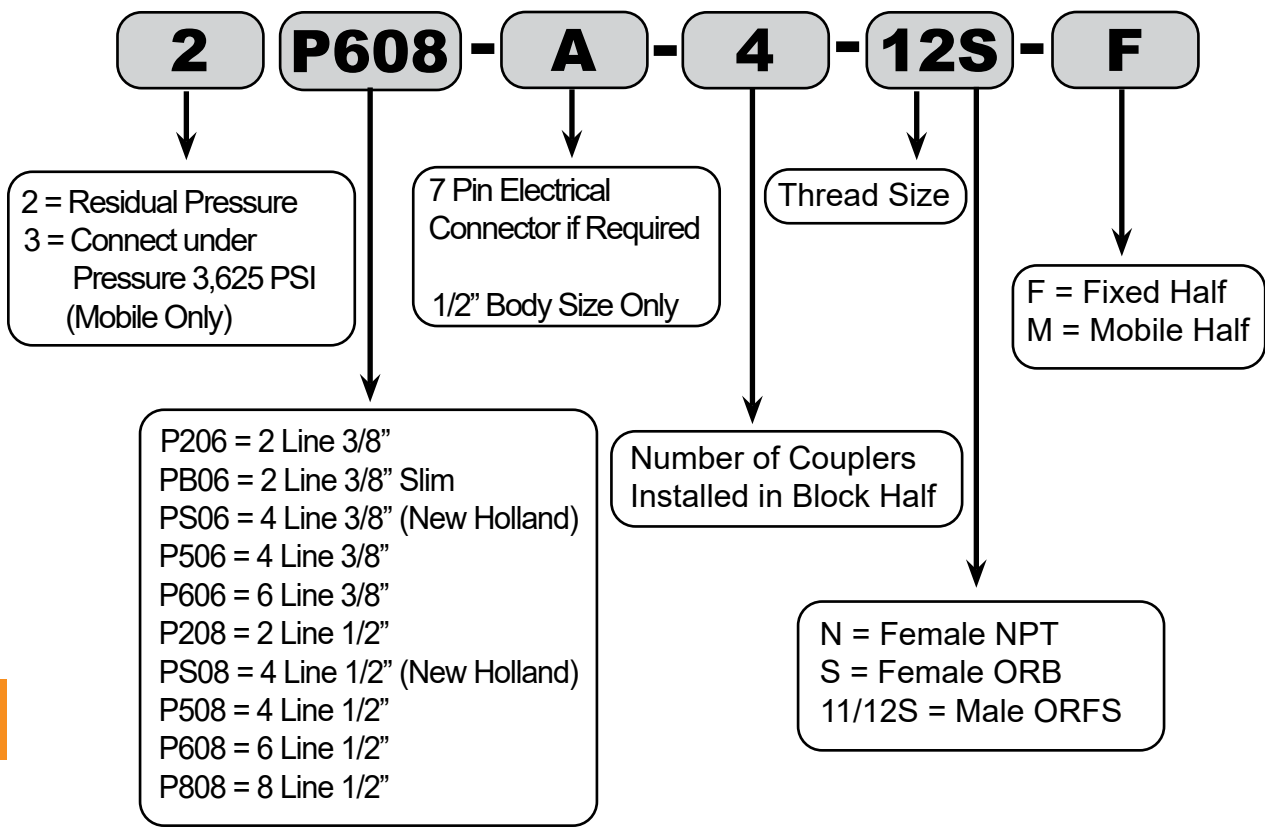

BECAUSE WE CONTINUALLY EXAMINE WAYS TO IMPROVE OUR PRODUCTS, WE RESERVE THE RIGHT TO ALTER SPECIFICATIONS WITHOUT NOTICE.

Multifaster - 2P206/3P206 - 2 Lines 3/8"



MOBILE HALF

| BODY SIZE | STEEL | THREAD | CONNECT PRESSURE |
|-----------|----------------|-------------------|------------------|
| 3/8" | 2P206-2-128S-M | -8 Female - ORB | Residual |
| 3/8" | 2P206-2-12N-M | 1/2" Female - NPT | Residual |
| | | | |
| 3/8" | 3P206-2-12S-M | -8 Female - ORB | 3,625 PSI |

FIXED HALF

| BODY SIZE | STEEL | THREAD | CONNECT PRESSURE |
|-----------|---------------|-------------------|------------------|
| 3/8" | 2P206-2-12S-F | -8 Female - ORB | Residual |
| 3/8" | 2P206-2-12N-F | 1/2" Female - NPT | Residual |

Multifaster - 2P208/3P208 - 2 Lines - 1/2"



MOBILE HALF

| BODY SIZE | STEEL | THREAD | CONNECT PRESSURE |
|-----------|------------------|-------------------|------------------|
| 1/2" | 2P208-2-12S-M | -8 Female - ORB | Residual |
| 1/2" | 2P208-2-12N-M | 1/2" Female - NPT | Residual |
| 1/2" | 2P208-2-11/12S-M | -8 Male - ORFS | Residual |
| | | | |
| 1/2" | 3P208-2-12S-M | -8 Female - ORB | 3,625 PSI |

FIXED HALF

| BODY SIZE | STEEL | THREAD | CONNECT PRESSURE |
|-----------|------------------|-------------------|------------------|
| 1/2" | 2P208-2-12S-F | -8 Female - ORB | Residual |
| 1/2" | 2P208-2-12N-F | 1/2" Female - NPT | Residual |
| 1/2" | 2P208-2-11/12S-F | -8 Male - ORFS | Residual |

BECAUSE WE CONTINUALLY EXAMINE WAYS TO IMPROVE OUR PRODUCTS, WE RESERVE THE RIGHT TO ALTER SPECIFICATIONS WITHOUT NOTICE.

Multifaster - 2PB06 - 2 Lines 3/8" - Compact



MOBILE HALF

| BODY SIZE | STEEL | THREAD | CONNECT PRESSURE |
|-----------|----------------|-------------------|------------------|
| 3/8" | 2PB06-2-38S-M | -6 Female - ORB | Residual |
| 3/8" | 2PB06-2-12S-M | -8 Female - ORB | Residual |
| 3/8" | 2PB06-2-12N-M | 1/2" Female - NPT | Residual |
| 3/8" | 3PB06-2-38S-MC | -6 Female -ORB | 3,625 PSI |
| 3/8" | 3PB06-2-12S-MC | -8 Female - ORB | 3,625 PSI |

FIXED HALF

| BODY SIZE | STEEL | THREAD | CONNECT PRESSURE |
|-----------|---------------|-------------------|------------------|
| 3/8" | 2PB06-2-12S-F | -8 Female - ORB | Residual |
| 3/8" | 2PB06-2-12N-F | 1/2" Female - NPT | Residual |

Multifaster - 2P506/3P506 - 4 Lines - 3/8"



MOBILE HALF

| BODY SIZE | STEEL | THREAD | CONNECT PRESSURE |
|-----------|----------------|-------------------|------------------|
| 3/8" | 2P506-4*-12S-M | -8 Female - ORB | Residual |
| 3/8" | 2P506-4*-12N-M | 1/2" Female - NPT | Residual |
| 3/8" | 2P506-11/12S-M | -8 Female - ORFS | Residual |
| 3/8" | 3P506-4*-12S-M | -8 Female - ORB | 3,625 PSI |

FIXED HALF

| BODY SIZE | STEEL | THREAD | CONNECT PRESSURE |
|-----------|----------------|-------------------|------------------|
| 3/8" | 2P506-4*-12S-F | -8 Female - ORB | Residual |
| 3/8" | 2P506-4*-12N-F | 1/2" Female - NPT | Residual |
| 3/8" | 2P506-11/12S-F | -8 Female - ORFS | Residual |

* Specify number of couplings

BECAUSE WE CONTINUALLY EXAMINE WAYS TO IMPROVE OUR PRODUCTS, WE RESERVE THE RIGHT TO ALTER SPECIFICATIONS WITHOUT NOTICE.

Multifaster - 2P508/3P508 - 4 Lines - 1/2"



MOBILE HALF

| BODY SIZE | STEEL | THREAD | CONNECT PRESSURE |
|-----------|-------------------|-------------------|------------------|
| 1/2" | 2P508-4*-12S-M | -8 Female - ORB | Residual |
| 1/2" | 2P508-4*-12N-M | 1/2" Female - NPT | Residual |
| 1/2" | 2P508-4*-11/12S-M | -8" Male - ORFS | Residual |
| 1/2" | 3P508-4*-12S-M | -8 Female - ORB | 3,625 PSI |

FIXED HALF

| BODY SIZE | STEEL | THREAD | CONNECT PRESSURE |
|-----------|-------------------|-------------------|------------------|
| 1/2" | 2P508-4*-12S-F | -8 Female - ORB | Residual |
| 1/2" | 2P508-4*-12N-F | 1/2" Female - NPT | Residual |
| 1/2" | 2P508-4*-11/12S-F | -8" Male - ORFS | Residual |

* Specify number of couplings

Multifaster - 2P606/3P606 - 6 Lines - 1/2"



MOBILE HALF

| BODY SIZE | STEEL | THREAD | CONNECT PRESSURE |
|-----------|-------------------|-------------------|------------------|
| 1/2" | 2P606-6*-12S-M | -8 Female - ORB | Residual |
| 1/2" | 2P606-6*-12N-M | 1/2" Female - NPT | Residual |
| 1/2" | 2P606-6*-11/12S-M | -8 Male - ORFS | Residual |
| 1/2" | 3P606-6*-12S-M | -8 Female - ORB | 3,625 PSI |

FIXED HALF

| BODY SIZE | STEEL | THREAD | CONNECT PRESSURE |
|-----------|-------------------|-------------------|------------------|
| 1/2" | 2P606-6*-12S-F | -8 Female - ORB | Residual |
| 1/2" | 2P606-6*-12N-F | 1/2" Female - NPT | Residual |
| 1/2" | 2P606-6*-11/12S-F | -8 Male - ORFS | Residual |

* Specify number of couplings

BECAUSE WE CONTINUALLY EXAMINE WAYS TO IMPROVE OUR PRODUCTS, WE RESERVE THE RIGHT TO ALTER SPECIFICATIONS WITHOUT NOTICE.

Multifaster - 2P608/3P608 - 6 Lines - 1/2"



MOBILE HALF

| BODY SIZE | STEEL | THREAD | CONNECT PRESSURE |
|-----------|-------------------|-------------------|------------------|
| 1/2" | 2P608-6*-12S-M | -8 Female - ORB | Residual |
| 1/2" | 2P608-6*-12N-M | 1/2" Female - NPT | Residual |
| 1/2" | 2P608-6*-11/12S-M | -8 Male - ORFS | Residual |
| 1/2" | 3P608-6*-12S-M | -8 Female - ORB | 3,625 PSI |

FIXED HALF

| BODY SIZE | STEEL | THREAD | CONNECT PRESSURE |
|-----------|-------------------|------------------------------------|------------------|
| 1/2" | 2P608-6*-12S-F | -8 Female - ORB | Residual |
| 1/2" | 2P608-6*-34S-F | -12 Female - ORB | Residual |
| 1/2" | 2P608-6*-12N-F | 1/2" Female - NPT | Residual |
| 1/2" | 2P608-6*-11/12S-F | -8 Male - ORFS | Residual |
| 1/2" | 2P608-6*-8BJFJWW | John Deere Style -8 Male - ORFS | Residual |

* Specify number of couplings

4

Multifaster

Multifaster - 2P808/3P808 - 8 Lines - 1/2"



MOBILE HALF

| BODY | STEEL | THREAD | CONNECT PRESSURE |
|------|-------------------|-----------------|------------------|
| 1/2" | 2P808-8*-12S-M | -8 Female - ORB | Residual |
| 1/2" | 2P808-8*-11/12S-M | -8 Male - ORFS | Residual |
| 1/2" | 3P808-8*-12S-M | -8 Female - ORB | 3,625 PSI |

FIXED HALF

| BODY | STEEL | THREAD | CONNECT PRESSURE |
|------|-------------------|-----------------|------------------|
| 1/2" | 2P808-8*-12S-F | -8 Female - ORB | Residual |
| 1/2" | 2P808-8*-11/12S-F | -8 Male - ORFS | Residual |

* Specify number of couplings

BECAUSE WE CONTINUALLY EXAMINE WAYS TO IMPROVE OUR PRODUCTS, WE RESERVE THE RIGHT TO ALTER SPECIFICATIONS WITHOUT NOTICE.

Multifaster - 2PS06/3PS06 - 4 Lines - 3/8"



MOBILE HALF

| BODY SIZE | STEEL | THREAD | CONNECT PRESSURE |
|-----------|----------------|-----------------|------------------|
| 3/8" | 2PS06-4*-12S-M | -8 Female - ORB | Residual |
| | | | |
| 3/8" | 3PS06-4*-12S-M | -8 Female - ORB | 3,625 PSI |

FIXED HALF

| BODY SIZE | STEEL | THREAD | CONNECT PRESSURE |
|-----------|----------------|-----------------|------------------|
| 3/8" | 2PS06-4*-12S-F | -8 Female - ORB | Residual |

* Specify number of couplings

Multifaster - 2PS08/3PS08 - 4 Lines - 1/2"



MOBILE HALF

| BODY SIZE | STEEL | THREAD | CONNECT PRESSURE |
|-----------|-------------------|-----------------|------------------|
| 1/2" | 2PS08-4*-12S-M | -8 Female - ORB | Residual |
| 1/2" | 2PS08-4*-11/12S-M | -8 Male - ORFS | Residual |
| | | | |
| 1/2" | 3PS08-4*-12S-M | -8 Female - ORB | 3,625 PSI |

FIXED HALF

| BODY SIZE | STEEL | THREAD | CONNECT PRESSURE |
|-----------|-------------------|-----------------|------------------|
| 1/2" | 2PS08-4*-12S-F | -8 Female - ORB | Residual |
| 1/2" | 2PS08-4*-11/12S-F | -8 Male - ORFS | Residual |

* Specify number of couplings

BECAUSE WE CONTINUALLY EXAMINE WAYS TO IMPROVE OUR PRODUCTS, WE RESERVE THE RIGHT TO ALTER SPECIFICATIONS WITHOUT NOTICE.

Multifaster - Replacement Parts

FIXED HALF

| BLOCK STYLE | BLOCK PART NUMBER (A+D+E+F) | COUPLER PART NUMBER (L) | SAFETY LOCK (A) | LEVER (D) | COVER (E) | ELECTRICAL CONNECTOR (H) | CABLE TERMINALS |
|-------------|-----------------------------|---|-----------------|-----------|-------------|--------------------------|-----------------|
| P206 | KIT-P206-F L | KIT2FNB38-NPT-F KIT2FNB38-12N-F KIT2FNB38-38S-F KIT2FNB38-12S-F | KIT-SP5-S | KIT-LP206 | KIT-TA-P2 | N/A | N/A |
| PB06 | KIT-PB06-F L | | KIT-SP5-S | KIT-LPB06 | KIT-TA-PB | | |
| PS06 | KIT-PS06-F L | | KIT-SP5-S | KIT-LP606 | KIT-TA-P6 | | |
| P506 | KIT-P506-F L | | KIT-SP5-S | KIT-LP506 | KIT-TA-P5 | | |
| P606 | KIT-P606-F L | | KIT-SP5-S | KIT-LP606 | KIT-TA-P6 | | |
| P208 | KIT-P208-F L | KIT2FNB12-NPT-F KIT2FNB12-12S-F KIT2FNB12-34S-F KIT2FNB12-11/12S-F | KIT-SP5-S | KIT-LP208 | KIT-TA-P2 | KIT-SPEL08-7F | KIT-CC-SPEL08-7 |
| PS08 | KIT-PS08-F L | | KIT-SP5-S | KIT-LPS08 | KIT-TA-P8 | | |
| P508 | KIT-P508-F L | | KIT-SP5-S | KIT-LP508 | KIT-TA-P5 | | |
| P608 | KIT-P608-F L | | KIT-SP5-S | KIT-LP608 | KIT-TA-P608 | | |
| P808 | KIT-P808-F L | | KIT-SP5-S | KIT-LP808 | KIT-TA-P8 | | |

4

Multifaster

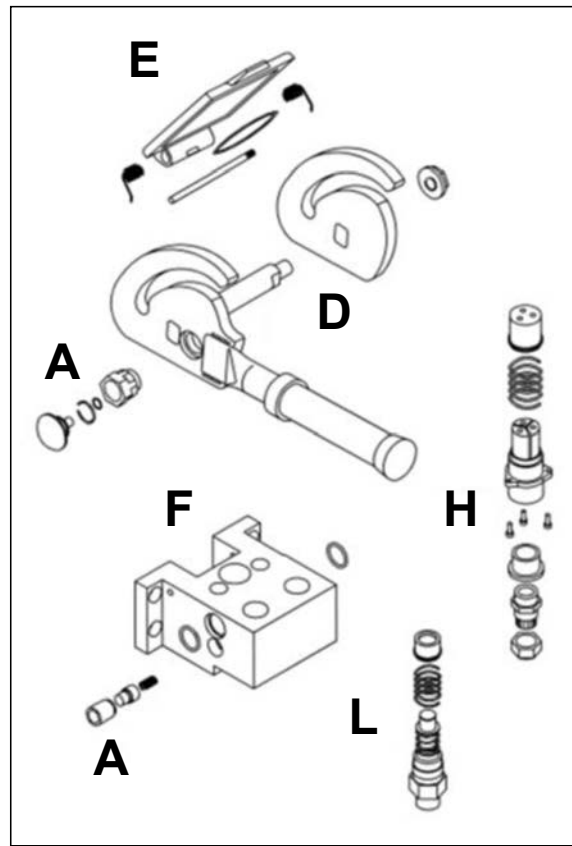

BECAUSE WE CONTINUALLY EXAMINE WAYS TO IMPROVE OUR PRODUCTS, WE RESERVE THE RIGHT TO ALTER SPECIFICATIONS WITHOUT NOTICE.

Multifaster - Replacement Parts

MOBILE HALF

| BLOCK STYLE | BLOCK PART NUMBER (G+B+C) | COUPLER PART NUMBER (M) | SCREW (B) | GUIDE PINS (C) | ELECTRICAL CONNECTOR (I) | CABLE TERMINALS | SEAL KIT (SK) | MOBILE PLATE SUPPORT |
|-------------|---------------------------|---|-----------|----------------|--------------------------|-----------------|---------------|----------------------|
| P206 | KIT-P206-M | KIT2FNP38-12N-M KIT2FNP38-38S-M KIT2FNP38-12S-M KIT3FNP38-38S-M KIT3FNP38-12S-M | KIT-VP4 | KIT-GP4 | N/A | N/A | SK-MF-38 | S-P2 |
| PB06 | KIT-PB06-M | | | KIT-GP4 | | | | S-PB |
| PS06 | KIT-PS06-M | | | KIT-GP4 | | | | S-PS |
| P506 | KIT-P506-M | | | KIT-GP4 | | | | S-P5 |
| P606 | KIT-P606-M | | | KIT-GP4 | | | | S-P6 |
| P208 | KIT-P208-M | KIT2FNP12-NPT-M KIT2FNP12-12S-M KIT2FNP12-34S-M KIT2FNP12-11/12S-M KIT3FNP12-NPT-M KIT3FNP12-12S-M KIT3FNP12-11/12S-M | KIT-VP8 | KIT-GP4 | KIT-SPEL08-7M | KIT-CC-SPEL08-7 | SK-MF-12 | S-P2 |
| PS08 | KIT-PS08-M | | | KIT-GP4 | | | | S-PS |
| P508 | KIT-P508-M | | | KIT-GP4 | | | | S-P5 |
| P608 | KIT-P608-M | | | KIT-GP4 | | | | S-P608 |
| P808 | KIT-P808-M | | | KIT-GP8 | | | | S-P8 |

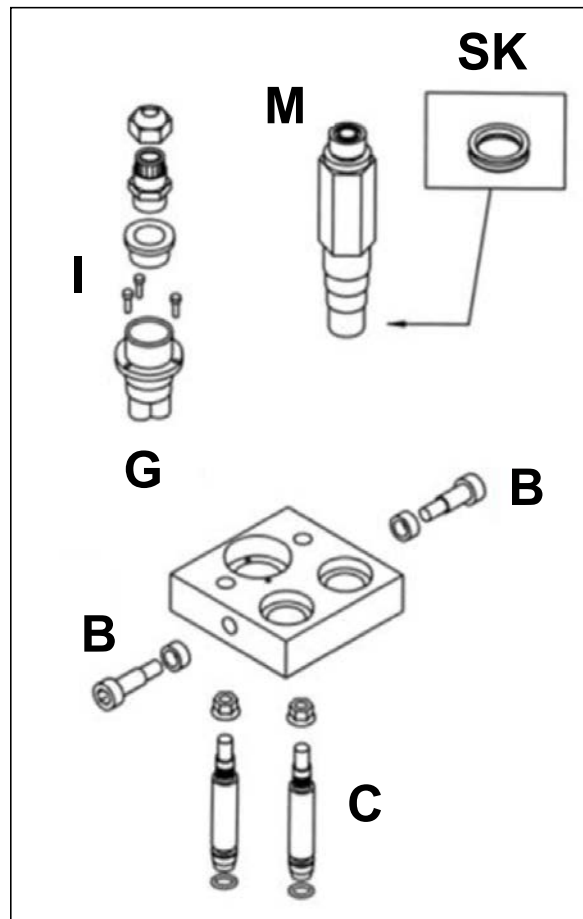

BECAUSE WE CONTINUALLY EXAMINE WAYS TO IMPROVE OUR PRODUCTS, WE RESERVE THE RIGHT TO ALTER SPECIFICATIONS WITHOUT NOTICE.

QWN Series - Wing Nut

Coupler



Standard



Faster

Nipple



Standard



Faster

Features

- Poppet valve
- Nitrile seals
- -22°F to +250°F (-30°C to +125°C)
- Connection: Screw to Connect
- Disconnection: Unscrew to Disconnect
- Connect under pressure: Allowed Residual

Applications

- Wet Line Hydraulic Systems
- Oilfield
- Mobile Drilling Rigs
- Submersible Pumps
- Mobile Equipment

Interchange

- Parker 6100
- Eaton 5100
- Faster FB
- Stucchi W
- Dixon W
- Snap-Tite 78
- Safeway S51

MAX WORKING PRESSURE - STANDARD

| BODY SIZE | (PSI) |
|-----------|-------|
| ¾" | 3,000 |
| 1" | 3,000 |
| 1-¼" | 3,000 |
| 1-½" | 2,500 |

MAX WORKING PRESSURE - FASTER

| BODY SIZE | (PSI) |
|-----------|-------|
| ¾" | 3,625 |
| 1" | 3,335 |
| 1-¼" | 3,045 |
| 1-½" | 2,900 |

BECAUSE WE CONTINUALLY EXAMINE WAYS TO IMPROVE OUR PRODUCTS, WE RESERVE THE RIGHT TO ALTER SPECIFICATIONS WITHOUT NOTICE.

QWN Series - Wing Nut

STANDARD (QWNC)

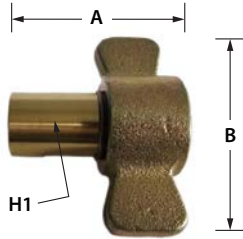

FASTER (FB)

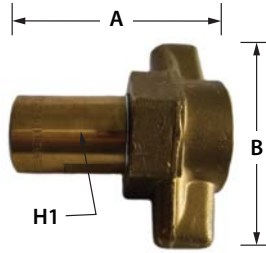

COUPLER

| BODY SIZE | THREAD SIZE | STEEL | DIMENSIONS (in) | | |
|-----------|-----------------------|----------------|-----------------|------|------|
| | | | A | B | H1 |
| 3/4" | 1/2" - Female - NPT | QWNC128FP | 3.06 | 4.07 | 1.15 |
| 3/4" | 3/4" - Female - NPT | QWNC1212FP | 3.06 | 4.07 | 1.15 |
| 1" | 1" - Female - NPT | QWNC1616FP | 3.76 | 4.44 | 1.44 |
| 1-1/4" | 1-1/4" - Female - NPT | QWNC2020FP | 3.91 | 5.40 | 1.77 |
| 1-1/2" | 1-1/2" - Female - NPT | QWNC2424FP | 4.08 | 5.42 | 2.00 |
| 3/4" | 3/4" - Female - NPT | FB12-34NPT-F5 | 3.19 | 3.54 | 1.18 |
| 1" | 1" - Female - NPT | FB16-1NPT-F5 | 3.57 | 3.92 | 1.42 |
| 1-1/4" | 1-1/4" - Female - NPT | FB20-114NPT-F5 | 3.74 | 5.00 | 1.77 |
| 1-1/2" | 1-1/2" - Female - NPT | FB24-112NPT-F5 | 4.34 | 5.91 | 1.97 |

DUST PLUG FOR COUPLER

| BODY SIZE | METAL |
|-----------|---------|
| 3/4" | QWN12DP |
| 1" | QWN16DP |
| 1-1/4" | QWN20DP |
| 1-1/2" | QWN24DP |

STANDARD (QWNN)

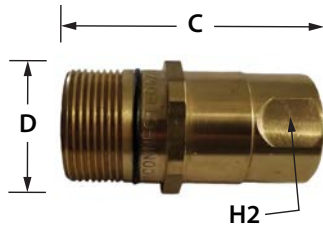

FASTER (FB)

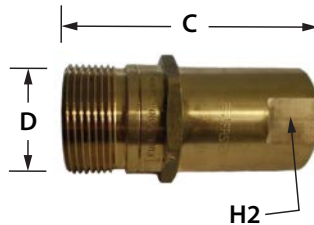

NIPPLE

| BODY SIZE | THREAD SIZE | STEEL | DIMENSIONS (in) | | |
|-----------|-----------------------|----------------|-----------------|------|------|
| | | | C | D | H2 |
| 3/4" | 1/2" - Female - NPT | QWNN128FP | 3.11 | 1.47 | 1.31 |
| 3/4" | 3/4" - Female - NPT | QWNN1212FP | 3.11 | 1.47 | 1.31 |
| 1" | 1" - Female - NPT | QWNN1616FP | 3.54 | 1.85 | 1.56 |
| 1-1/4" | 1-1/4" - Female - NPT | QWNN2020FP | 3.72 | 2.11 | 1.87 |
| 1-1/2" | 1-1/2" - Female - NPT | QWNN2424FP | 4.12 | 2.47 | 2.25 |
| 3/4" | 3/4" - Female - NPT | FB12-34NPT-M5 | 3.22 | 1.47 | 1.34 |
| 1" | 1" - Female - NPT | FB16-1NPT-M5 | 3.50 | 1.85 | 1.57 |
| 1-1/4" | 1-1/4" - Female - NPT | FB20-114NPT-M5 | 3.82 | 2.11 | 1.89 |
| 1-1/2" | 1-1/2" - Female - NPT | FB24-112NPT-M5 | 4.33 | 2.47 | 2.17 |

DUST CAP FOR NIPPLE

| BODY SIZE | METAL |
|-----------|---------|
| 3/4" | QWN12DC |
| 1" | QWN16DC |
| 1-1/4" | QWN20DC |
| 1-1/2" | QWN24DC |

Q75 Series - HP Wing Nut

Coupler



Nipple



Features

- Poppet valve
- Nitrile seals / PTFE Back-up ring
- -22°F to +212°F (-30°C to +100°C)
- Connection: Screw to Connect
- Disconnection: Unscrew to Disconnect
- Connect under pressure: Allowed Residual

Applications

- Piling Hammers
- Augers
- Oil & Gas
- Mobile Equipment

Interchange

- Eaton FD85
- Faster OGV
- Stucchi VOF
- Snap-Tite 75
- Dixon WS
- Hydraulic Inc 5TV

5

Screw to Connect

MAX WORKING PRESSURE (PSI)

| BODY SIZE | STEEL |
|-----------|-------|
| ¾" | 5,000 |
| 1" | 5,000 |
| 1-¼" | 5,000 |
| 1-½" | 5,000 |
| 2" | 5,000 |

BECAUSE WE CONTINUALLY EXAMINE WAYS TO IMPROVE OUR PRODUCTS, WE RESERVE THE RIGHT TO ALTER SPECIFICATIONS WITHOUT NOTICE.

Q75 Series - HP Wing Nut

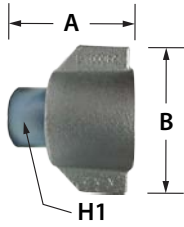

COUPLER

| BODY SIZE | THREAD SIZE | STEEL | DIMENSIONS (IN) | | |
|-----------|-----------------------|------------|-----------------|--------|------|
| | | | A | B | H1 |
| 3/4" | 3/4" - Female - NPT | Q75C1212FP | 2.84 | 2.17 | 1.26 |
| 1" | 1" - Female - NPT | Q75C1616FP | 3.45 | 4.15 | 1.61 |
| 1-1/4" | 1-1/4" - Female - NPT | Q75C2020FP | 4.41 | 4.65 | 1.97 |
| 1-1/2" | 1-1/2" - Female - NPT | Q75C2424FP | 5.00 | 5.79 | 2.17 |
| 2" | 2" - Female - NPT | Q75C3232FP | 6.07 | 6.69 | 2.95 |
| 1-1/2" | 1-1/2" Code 62 | 6TVC6-FP24 | 172.70 | 114.30 | -- |
| 2" | 2" Code 62 | 6TVC6-FH32 | 274.80 | 196.90 | -- |

DUST CAP FOR COUPLER

| BODY SIZE | METAL |
|-----------|---------|
| 3/4" | Q7512DP |
| 1" | Q7516DP |
| 1-1/4" | Q7520DP |
| 1-1/2" | Q7524DP |
| 2" | Q7532DP |

FP = Flange Port (Block)
FH = Flange Head

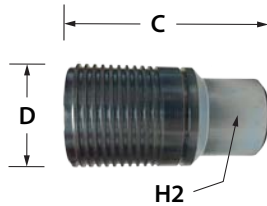

NIPPLE

| BODY SIZE | THREAD SIZE | STEEL | DIMENSIONS (IN) | | |
|-----------|-----------------------|------------|-----------------|--------|-------|
| | | | C | D | H2 |
| 3/4" | 3/4" - Female - NPT | Q75N1212FP | 3.27 | 1.74 | 1.26 |
| 1" | 1" - Female - NPT | Q75N1616FP | 4.17 | 2.25 | 1.61 |
| 1-1/4" | 1-1/4" - Female - NPT | Q75N2020FP | 5.37 | 2.62 | 1.47 |
| 1-1/2" | 1-1/2" - Female - NPT | Q75N2424FP | 5.97 | 3.25 | 2.17 |
| 2" | 2" - Female - NPT | Q75N3232FP | 7.05 | 4.00 | 2.95T |
| 1-1/2" | 1-1/2" Code 62 | 6TVN6-FP24 | 196.60 | 82.60 | Block |
| 2" | 2" Code 62 | 6TVN6-FH32 | 299.70 | 101.60 | Block |

DUST CAP FOR NIPPLE

| BODY SIZE | METAL |
|-----------|---------|
| 3/4" | Q7512DC |
| 1" | Q7516DC |
| 1-1/4" | Q7520DC |
| 1-1/2" | Q7524DC |
| 2" | Q7532DC |

FP = Flange Port (Block)
FH = Flange Head

BECAUSE WE CONTINUALLY EXAMINE WAYS TO IMPROVE OUR PRODUCTS, WE RESERVE THE RIGHT TO ALTER SPECIFICATIONS WITHOUT NOTICE.

QJ Series - Hydraulic Jack

Coupler



Poppet



Ball

Nipple



Poppet



Ball

Features

- Poppet valve
- Nitrile seals / PTFE Back-up ring
- -22°F to +250°F (-30°C to +125°C)
- Connection: Screw to Connect
- Disconnection: Unscrew to Disconnect
- Connect under pressure: Allowed Residual

Applications

- Hydraulic Jacks
- High Pressure Test Stands
- Hydraulic Tools

Interchange

- ISO 14540
- Parker 3000
- Faster PVVM / PVSM
- Stucchi IVHP
- Snap-Tite 76
- Safeway S30
- Enerpac C604
- Dixon T

MAX WORKING PRESSURE - POPPET

| BODY SIZE | (PSI) |
|-----------|--------|
| 1/4" | 14,500 |
| 3/8" | 14,500 |

MAX WORKING PRESSURE - BALL

| BODY SIZE | (PSI) |
|-----------|--------|
| 1/4" | 10,000 |
| 3/8" | 10,000 |

BECAUSE WE CONTINUALLY EXAMINE WAYS TO IMPROVE OUR PRODUCTS, WE RESERVE THE RIGHT TO ALTER SPECIFICATIONS WITHOUT NOTICE.

QJ Series - Hydraulic Jack

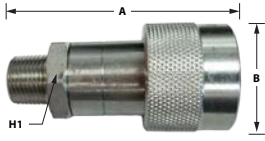

COUPLER - POPPET

| BODY SIZE | THREAD SIZE | STEEL | DIMENSIONS (IN) | | |
|-----------|---------------------|-----------|-----------------|------|------|
| | | | A | B | H1 |
| 1/4" | 1/4" - Male - NPT | QJC44MP-P | 2.46 | 1.17 | 0.82 |
| 3/8" | 3/8" Male - NPT | QJC66MP-P | 3.26 | 1.42 | 0.98 |
| 3/8" | 3/8" Female - NPT | QJC66FP-P | 2.87 | 1.33 | 0.97 |
| 1/4" | 1/4" - Female - NPT | QJC44FP-P | 2.28 | 1.12 | 0.85 |

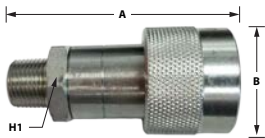

COUPLER - BALL

| BODY SIZE | THREAD SIZE | STEEL | DIMENSIONS (IN) | | |
|-----------|---------------------|-----------|-----------------|------|------|
| | | | A | B | H1 |
| 1/4" | 1/4" - Male - NPT | QJC44MP-B | 2.35 | 1.12 | 0.85 |
| 3/8" | 3/8" - Male - NPT | QJC66MP-B | 2.87 | 1.33 | 0.97 |
| 3/8" | 3/8" - Female - NPT | QJC66FP-B | 2.87 | 1.33 | 0.97 |
| 1/4" | 1/4" - Female - NPT | QJC44FP-B | 2.28 | 1.12 | 0.85 |

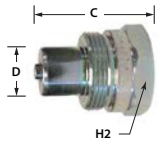

NIPPLE - POPPET

| BODY SIZE | THREAD SIZE | STEEL | DIMENSIONS (IN) | | |
|-----------|---------------------|-----------|-----------------|------|------|
| | | | C | D | H2 |
| 1/4" | 1/4" - Female - NPT | QJN44FP-P | 1.39 | 0.61 | 1.05 |
| 3/8" | 3/8" - Female - NPT | QJN66FP-P | 1.62 | 0.73 | 1.24 |

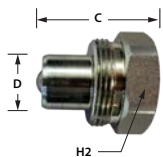

NIPPLE - BALL

| BODY SIZE | THREAD SIZE | STEEL | DIMENSIONS (IN) | | |
|-----------|---------------------|-----------|-----------------|------|------|
| | | | C | D | H2 |
| 1/4" | 1/4" - Female - NPT | QJN44FP-B | 1.33 | 0.61 | 0.73 |
| 3/8" | 3/8" - Female - NPT | QJN66FP-B | 1.45 | 0.73 | 1.24 |



DUST PLUG FOR COUPLER

| BODY SIZE | METAL |
|-----------|-------|
| 1/4" | QJ4DP |
| 3/8" | QJ6DP |



DUST CAP FOR NIPPLE

| BODY SIZE | METAL |
|-----------|-------|
| 1/4" | QJ4DC |
| 3/8" | QJ6DC |

BECAUSE WE CONTINUALLY EXAMINE WAYS TO IMPROVE OUR PRODUCTS, WE RESERVE THE RIGHT TO ALTER SPECIFICATIONS WITHOUT NOTICE.

QV/QVS Series

Coupler



QV

QVS

Nipple



QV

QVS

Features

- Poppet valve
- Nitrile seals / PTFE Back-up ring
- -22°F to +250°F (-30°C to +125°C)
- Connection: Screw to Connect
- Disconnection: Unscrew to Disconnect
- Connect under pressure: Allowed Residual

Applications

- Snow Plow
- Industrial
- Mobile Equipment
- Transportation
- Oil & Gas

Interchange

- Faster VV/VVS

MAX WORKING PRESSURE (PSI) QV

| BODY SIZE | STEEL |
|-----------|-------|
| 1/4" | 5,075 |
| 3/8" | 4,350 |
| 1/2" | 3,625 |
| 3/4" | 3,625 |
| 1" | 3,200 |

MAX WORKING PRESSURE (PSI) QVS

| BODY SIZE | STEEL |
|-----------|--------|
| 1/4" | 11,600 |
| 3/8" | 11,600 |
| 1/2" | 10,150 |
| 3/4" | 10,150 |
| 1" | 9,135 |
| 1-1/4" | 8,700 |
| 1-1/2" | 5,800 |
| 2" | 5,075 |

BECAUSE WE CONTINUALLY EXAMINE WAYS TO IMPROVE OUR PRODUCTS, WE RESERVE THE RIGHT TO ALTER SPECIFICATIONS WITHOUT NOTICE.

QV/QVS Series

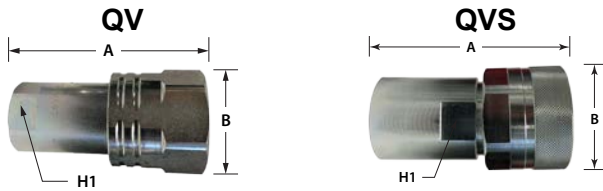

COUPLER

| BODY SIZE | THREAD SIZE | STEEL | MAX WORKING PRESSURE (PSI) | FLOW RATE (gpm) | DIMENSIONS (IN) | | |
|-----------|-------------|------------|----------------------------|-----------------|-----------------|------|------|
| | | | | | A | B | H1 |
| 1/4" | 1/4" NPT | QVC44FP | 5,075 | 4.76 | 2.36 | 1.18 | 0.75 |
| 3/8" | 3/8" NPT | QVC66FP | 4,350 | 7.93 | 2.83 | 1.50 | 0.95 |
| 1/2" | 1/2" NPT | QVC88FP | 3,625 | 17.17 | 3.11 | 1.65 | 1.06 |
| 3/4" | 3/4" NPT | QVC1212FP | 3,625 | 26.42 | 4.17 | 2.16 | 1.34 |
| 1" | 1" NPT | QVC1616FP | 3,200 | 36.98 | 4.88 | 2.42 | 1.61 |
| 1/4" | 1/4" NPT | QVSC44FP | 11,600 | 2.11 | 2.68 | 1.18 | 0.87 |
| 3/8" | 3/8" NPT | QVSC66FP | 11,600 | 4.76 | 3.00 | 1.57 | 1.18 |
| 1/2" | 1/2" NPT | QVSC88FP | 10,150 | 10.57 | 3.42 | 1.77 | 1.33 |
| 3/4" | 3/4" NPT | QVSC1212FP | 10,150 | 14.53 | 4.17 | 2.16 | 1.61 |
| 1" | 1" NPT | QVSC1616FP | 9,135 | 26.42 | 4.88 | 2.36 | 1.92 |
| 1-1/4" | 1-1/4" NPT | QVSC2020FP | 8,700 | 36.98 | 5.98 | 3.14 | 2.56 |
| 1-1/2" | 1-1/2" NPT | QVSC2424FP | 5,800 | 79.25 | 6.77 | 3.86 | 2.95 |
| 2" | 2" NPT | QVSC3232FP | 5,075 | 264.20 | 8.11 | 5.08 | 3.94 |

QV

QVS



DUST PLUG FOR COUPLER

| BODY SIZE | METAL |
|-----------|--------|
| 1/4" | QV4DP |
| 3/8" | QV6DP |
| 1/2" | QV8DP |
| 3/4" | QV12DP |
| 1" | QV16DP |
| 1-1/4" | QV20DP |
| 1-1/2" | QV24DP |
| 2" | QV32DP |

QV/QVS Series

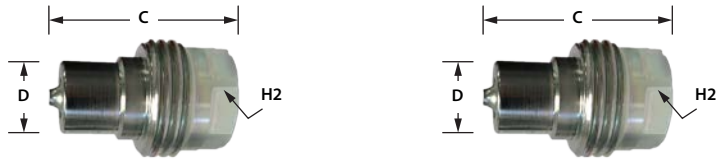

NIPPLE

| BODY SIZE | THREAD SIZE | STEEL | MAX WORKING PRESSURE (PSI) | FLOW RATE (gpm) | DIMENSIONS (IN) | | |
|-----------|-------------|------------|----------------------------|-----------------|-----------------|------|------|
| | | | | | C | D | H2 |
| 1/4" | 1/4" NPT | QVN44FP | 5,075 | 4.76 | 1.30 | 0.56 | 0.75 |
| 3/8" | 3/8" NPT | QVN66FP | 4,350 | 7.93 | 1.60 | 0.75 | 0.95 |
| 1/2" | 1/2" NPT | QVN88FP | 3,625 | 17.17 | 1.93 | 0.81 | 1.06 |
| 3/4" | 3/4" NPT | QVN1212FP | 3,625 | 26.42 | 2.44 | 0.81 | 1.10 |
| 1" | 1" NPT | QVN1616FP | 3,200 | 36.98 | 2.84 | 1.25 | 1.61 |
| 1/4" | 1/4" NPT | QVSN44FP | 11,600 | 2.11 | 1.89 | 0.56 | 1.00 |
| 3/8" | 3/8" NPT | QVSN66FP | 11,600 | 4.76 | 1.89 | 0.75 | 1.18 |
| 1/2" | 1/2" NPT | QVSN88FP | 10,150 | 10.57 | 2.09 | 0.81 | 1.34 |
| 3/4" | 3/4" NPT | QVSN1212FP | 10,150 | 14.53 | 2.48 | 1.10 | 1.77 |
| 1" | 1" NPT | QVSN1616FP | 9,135 | 26.42 | 2.83 | 1.25 | 1.97 |
| 1-1/4" | 1-1/4" NPT | QVSN2020FP | 8,700 | 36.98 | 3.39 | 1.72 | 2.56 |
| 1-1/2" | 1-1/2" NPT | QVSN2424FP | 5,800 | 70.25 | 3.74 | 2.10 | 3.15 |
| 2" | 2" NPT | QVSN3232FP | 5,075 | 264.20 | 4.65 | 3.22 | 4.33 |

DUST CAP FOR NIPPLE

| BODY SIZE | METAL |
|-----------|--------|
| 1/4" | QV4DC |
| 3/8" | QV6DC |
| 1/2" | QV8DC |
| 3/4" | QV12DC |
| 1" | QV16DC |
| 1-1/4" | QV20DC |
| 1-1/2" | QV24DC |
| 2" | QV32DC |

BECAUSE WE CONTINUALLY EXAMINE WAYS TO IMPROVE OUR PRODUCTS, WE RESERVE THE RIGHT TO ALTER SPECIFICATIONS WITHOUT NOTICE.

QTP Series - Diagnostic Coupler

Coupler



Features

- Flat face valve
- -22°F to +250°F (-30°C to +121°C)
- Connection: Push to Connect
- Disconnection: Sleeve Retraction
- Connection Under Pressure: Not Allowed
- Max Working Pressure: 6,800 PSI

Nipple



Applications

- Use to connect/disconnect pressure gauges to hydraulic systems, eliminating the need for permanent gauges.

Interchange

- ISO 15171-1
- Parker PD
- Eaton FD90
- Faster DF
- Dixon PD

BECAUSE WE CONTINUALLY EXAMINE WAYS TO IMPROVE OUR PRODUCTS, WE RESERVE THE RIGHT TO ALTER SPECIFICATIONS WITHOUT NOTICE.

QTP Series - Diagnostic Coupler

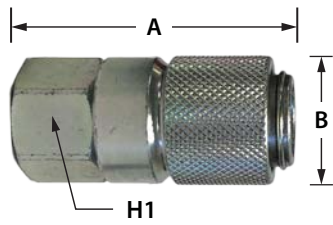

COUPLER

| BODY SIZE | THREAD SIZE | STEEL | DIMENSIONS (in) | | |
|-----------|-------------------------|-----------|-----------------|------|------|
| | | | A | B | H1 |
| 1/8" | 1/8" - Female NPT | QTPC22FP | 1.65 | 0.95 | 0.83 |
| 1/8" | 1/4" - Female NPT | QTPC24FP | 1.97 | 0.95 | 0.83 |
| 1/8" | 1/4" - Male NPT | QTPC24MP | 2.20 | 0.95 | 0.83 |
| 1/8" | 7/16" - 24 - Female ORB | QTPC24FOB | 2.13 | 0.95 | 0.83 |
| 1/8" | 9/16" - 18 - Female ORB | QTPC26FOB | 2.13 | 0.95 | 0.83 |

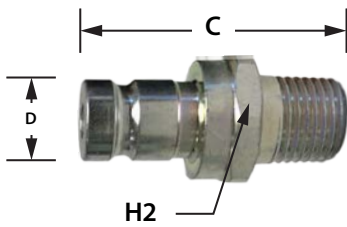

NIPPLE

| BODY SIZE | THREAD SIZE | STEEL | DIMENSIONS (in) | | |
|-----------|-------------------------|------------|-----------------|------|------|
| | | | C | D | H2 |
| 1/8" | 1/8" - Female NPT | QTPN22FP | 1.42 | 0.50 | 0.75 |
| 1/8" | 1/4" - Female NPT | QTPN24FP | 1.58 | 0.50 | 0.75 |
| 1/8" | 1/8" - Male NPT | QTPN22MP | 1.61 | 0.50 | 0.67 |
| 1/8" | 1/4" - Male NPT | QTPN24MP | 1.62 | 0.50 | 0.75 |
| 1/8" | 5/16" - 24 - Male ORB | QTPN22MOB | 1.53 | 0.50 | 0.67 |
| 1/8" | 7/16" - 24 - Male - ORB | QTPN24MOB | 1.53 | 0.50 | 0.67 |
| 1/8" | 9/16" - 18 - Male - ORB | QTPN26MOB | 1.53 | 0.50 | 0.67 |
| 1/8" | M14 x 1.5 - Male | QTPN214MML | 1.66 | 0.50 | 0.75 |

DUST CAP FOR NIPPLE

| BODY SIZE | RUBBER |
|-----------|--------|
| 1/8" | QTP2DC |



BECAUSE WE CONTINUALLY EXAMINE WAYS TO IMPROVE OUR PRODUCTS, WE RESERVE THE RIGHT TO ALTER SPECIFICATIONS WITHOUT NOTICE.

QH Series - Valved

Coupler



Nipple



Features

- Poppet valve
- Nitrile seals / PTFE Back-up ring
- -22°F to +250°F (-30°C to +125°C)
- Connection: Sleeve Retraction
- Disconnection: Sleeve Retraction
- Connect under pressure: Not Allowed

Applications

- Industrial
- Mobile Equipment
- Oil & Gas

Interchange

- MIL-C-51234
- Snap-Tite H/IH
- Faster TNV/TNL
- Dixon V

MAX WORKING PRESSURE (PSI)

| BODY SIZE | STEEL |
|-----------|-------|
| 1/4" | 6,500 |
| 3/8" | 4,500 |
| 1/2" | 4,000 |
| 3/4" | 3,500 |
| 1" | 2,000 |
| 1-1/4" | 1,750 |
| 1-1/2" | 1,500 |
| 2" | 1,500 |

BECAUSE WE CONTINUALLY EXAMINE WAYS TO IMPROVE OUR PRODUCTS, WE RESERVE THE RIGHT TO ALTER SPECIFICATIONS WITHOUT NOTICE.

QH Series - Valved

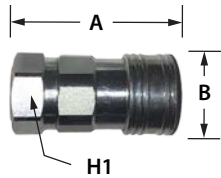

COUPLER

| BODY SIZE | THREAD SIZE | STEEL | DIMENSIONS (IN) | | |
|-----------|-----------------------|-----------|-----------------|------|------|
| | | | A | B | H1 |
| 1/4" | 1/4" - Female - NPT | QHC44FP | 1.68 | 0.99 | 0.88 |
| 3/8" | 3/8" - Female - NPT | QHC66FP | 1.94 | 1.18 | 1.00 |
| 1/2" | 1/2" - Female - NPT | QHC88FP | 2.13 | 1.36 | 1.19 |
| 3/4" | 3/4" - Female - NPT | QHC1212FP | 2.47 | 1.67 | 1.50 |
| 1" | 1" - Female - NPT | QHC1616FP | 2.70 | 2.06 | 1.88 |
| 1-1/4" | 1-1/4" - Female - NPT | QHC2020FP | 3.54 | 2.19 | 2.00 |
| 1-1/2" | 1-1/2" - Female - NPT | QHC2424FP | 3.27 | 2.74 | 2.50 |
| 2" | 2" - Female - NPT | QHC3232FP | 3.92 | 3.83 | 3.50 |



DUST PLUG FOR COUPLER

| BODY SIZE | RUBBER |
|-----------|--------|
| 1/4" | QH4DP |
| 3/8" | QH6DP |
| 1/2" | QH8DP |
| 3/4" | QH12DP |
| 1" | QH16DP |

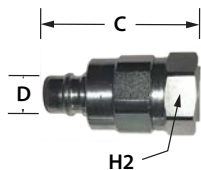

NIPPLE

| BODY SIZE | THREAD SIZE | STEEL | DIMENSIONS (IN) | | |
|-----------|-----------------------|-----------|-----------------|------|------|
| | | | C | D | H2 |
| 1/4" | 1/4" - Female - NPT | QHN44FP | 1.62 | 0.43 | 0.88 |
| 3/8" | 3/8" - Female - NPT | QHN66FP | 1.87 | 0.51 | 1.00 |
| 1/2" | 1/2" - Female - NPT | QHN88FP | 1.99 | 0.63 | 1.19 |
| 3/4" | 3/4" - Female - NPT | QHN1212FP | 2.31 | 0.92 | 1.50 |
| 1" | 1" - Female - NPT | QHN1616FP | 2.60 | 1.17 | 1.88 |
| 1-1/4" | 1-1/4" - Female - NPT | QHN2020FP | 3.54 | 1.42 | 2.00 |
| 1-1/2" | 1-1/2" - Female - NPT | QHN2424FP | 3.27 | 1.71 | 2.50 |
| 2" | 2" - Female - NPT | QHN3232FP | 3.97 | | 3.50 |



DUST CAP FOR NIPPLE

| BODY SIZE | RUBBER |
|-----------|--------|
| 1/4" | QH4DC |
| 3/8" | QH6DC |
| 1/2" | QH8DC |
| 3/4" | QH12DC |
| 1" | QH16DC |

BECAUSE WE CONTINUALLY EXAMINE WAYS TO IMPROVE OUR PRODUCTS, WE RESERVE THE RIGHT TO ALTER SPECIFICATIONS WITHOUT NOTICE.

QTE Series - European

Coupler



Nipple



Features

- Poppet valve
- Nitrile seals / PTFE Back-up ring
- -22°F to +250°F (-30°C to +125°C)
- Connection: Sleeve Retraction
- Disconnection: Sleeve Retraction
- Connect under pressure: Not Allowed

Applications

- Industrial
- Mobile Equipment
- Hydraulic Tools

Interchange

- MIL-C-51234
- Tema 3800, 5000, 7500, 10000
- CEJN 525
- Dixon TR

MAX WORKING PRESSURE (PSI)

| BODY SIZE | STEEL |
|-----------|-------|
| 3/8" | 5,000 |
| 1/2" | 4,000 |
| 3/4" | 4,000 |
| 1" | 3,200 |

BECAUSE WE CONTINUALLY EXAMINE WAYS TO IMPROVE OUR PRODUCTS, WE RESERVE THE RIGHT TO ALTER SPECIFICATIONS WITHOUT NOTICE.

QTE Series - European

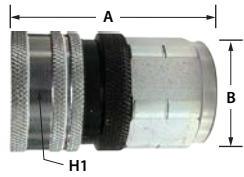

COUPLER

| BODY SIZE | THREAD SIZE | STEEL | DIMENSIONS (IN) | | |
|-----------|---------------------|--------------|-----------------|------|------|
| | | | A | B | H1 |
| 3/8" | 3/8" - Female - NPT | QTEC66FP | 2.52 | 1.38 | 1.18 |
| 1/2" | 1/2" - Female - NPT | QTEC88FP | 2.62 | 1.57 | 1.42 |
| 3/4" | 3/4" - Female - NPT | QTEC1212FP | 3.35 | 2.05 | 2.05 |
| 1" | 1" - Female - NPT | QTEC1616FP | 3.90 | 2.56 | 2.17 |
| 3/8" | 3/8" - Female - BSP | QTEC66FBSP | 2.52 | 1.38 | 1.18 |
| 1/2" | 1/2" - Female - BSP | QTEC88FBSP | 2.62 | 1.57 | 1.42 |
| 3/4" | 3/4" - Female - BSP | QTEC1212FBSP | 3.35 | 2.05 | 2.05 |
| 1" | 1" - Female - BSP | QTEC1616FBSP | 3.90 | 2.56 | 2.17 |



DUST PLUG FOR COUPLER

| BODY SIZE | RUBBER |
|-----------|--------|
| 3/8" | QT6DP |
| 1/2" | QT8DP |
| 3/4" | QT12DP |
| 1" | QT16DP |

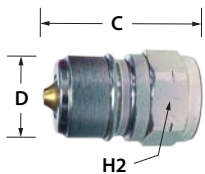

NIPPLE

| BODY SIZE | THREAD SIZE | STEEL | DIMENSIONS (IN) | | |
|-----------|---------------------|--------------|-----------------|------|------|
| | | | C | D | H2 |
| 3/8" | 3/8" - Female - NPT | QTEN66FP | 1.59 | 0.78 | 0.87 |
| 1/2" | 1/2" - Female - NPT | QTEN88FP | 1.63 | 0.97 | 1.06 |
| 3/4" | 3/4" - Female - NPT | QTEN1212FP | 2.20 | 1.29 | 1.42 |
| 1" | 1" - Female - NPT | QTEN1616FP | 2.48 | 1.61 | 1.81 |
| 3/8" | 3/8" - Female - BSP | QTEN66FBSP | 1.59 | 0.78 | 0.87 |
| 1/2" | 1/2" - Female - BSP | QTEN88FBSP | 1.63 | 0.97 | 1.06 |
| 3/4" | 3/4" - Female - BSP | QTEN1212FBSP | 2.20 | 1.29 | 1.42 |
| 1" | 1" - Female - BSP | QTEN1616FBSP | 2.48 | 1.61 | 1.81 |



DUST CAP FOR NIPPLE

| BODY SIZE | RUBBER |
|-----------|--------|
| 3/8" | QT6DC |
| 1/2" | QT8DC |
| 3/4" | QT12DC |
| 1" | QT16DC |

BECAUSE WE CONTINUALLY EXAMINE WAYS TO IMPROVE OUR PRODUCTS, WE RESERVE THE RIGHT TO ALTER SPECIFICATIONS WITHOUT NOTICE.

QA Series - ISO A

Coupler



Nipple



Features

- Poppet valve
- Nitrile seals / PTFE Back-up ring
- -22°F to +250°F (-30°C to +125°C)
- Connection: Sleeve Retraction
- Disconnection: Sleeve Retraction
- Connect under pressure: Not Allowed

Applications

- Agricultural
- Industrial
- Mobile Equipment
- Transportation
- Oil & Gas

Interchange

- ISO 7241 - A
- Parker 6600
- Eaton FD56
- Faster ANV
- Stucchi BIR
- Dixon K

MAX WORKING PRESSURE

| BODY SIZE | (PSI) |
|-----------|-------|
| ¼" | 7,000 |
| ⅜" | 4,350 |
| ½" | 4,350 |
| ¾" | 4,350 |
| 1" | 3,625 |
| 1-¼" | 3,000 |
| 1-½" | 3,000 |
| 2" | 1,500 |

BECAUSE WE CONTINUALLY EXAMINE WAYS TO IMPROVE OUR PRODUCTS, WE RESERVE THE RIGHT TO ALTER SPECIFICATIONS WITHOUT NOTICE.

QA Series - ISO A

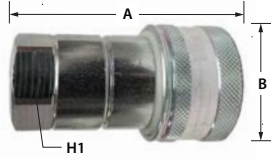

COUPLER

| BODY SIZE | THREAD SIZE | STEEL | DIMENSIONS (IN) | | |
|-----------|-----------------------------|-------------|-----------------|------|------|
| | | | A | B | H1 |
| 1/4" | 1/4" - Female - NPT | QAC44FP | 1.89 | 1.00 | 0.75 |
| 3/8" | 3/8" - Female - NPT | QAC66FP | 2.25 | 1.26 | 0.87 |
| 1/2" | 1/2" - Female - NPT | QAC88FP | 2.60 | 1.50 | 1.06 |
| 3/4" | 3/4" - Female - NPT | QAC1212FP | 3.25 | 1.89 | 1.34 |
| 1" | 1" - Female - NPT | QAC1616FP | 3.94 | 2.20 | 1.62 |
| 1-1/4" | 1-1/4" - Female - NPT | QAC2020FP | 4.57 | 2.76 | 1.97 |
| 1-1/2" | 1-1/2" - Female - NPT | QAC2424FP | 5.24 | 3.30 | 2.36 |
| 2" | 2" - Female - NPT | QAC3232FP | 6.34 | 3.94 | 2.95 |
| 1/4" | 7/16" - 20 - Female - ORB | QAC44FOB | 1.89 | 1.00 | 0.75 |
| 3/8" | 9/16" - 18 - Female - ORB | QAC66FOB | 2.25 | 1.26 | 0.87 |
| 1/2" | 3/4" - 16 - Female - ORB | QAC88FOB | 2.60 | 1.50 | 1.06 |
| 1/2" | 7/8" 14 - Female - ORB | QAC810FOB | 1.26 | 1.50 | 2.74 |
| 3/4" | 1-1/16" - 12 - Female - ORB | QAC1212FOB | 3.25 | 1.89 | 1.34 |
| 1" | 1-5/16" - 12 - Female - ORB | QAC1616FOB | 3.94 | 2.20 | 1.62 |
| 1/4" | 1/4" - Female - BSPP | QAC44FBSP | 1.89 | 1.00 | 0.75 |
| 3/8" | 3/8" - Female - BSPP | QAC66FBSP | 2.25 | 1.26 | 0.87 |
| 1/2" | 1/2" - Female - BSPP | QAC88FBSP | 2.60 | 1.50 | 1.06 |
| 3/4" | 3/4" - Female - BSPP | QAC1212FBSP | 3.25 | 1.89 | 1.34 |
| 1" | 1" - Female - BSPP | QAC1616FBSP | 3.94 | 2.20 | 1.62 |



DUST PLUG FOR COUPLER

| BODY SIZE | RUBBER |
|-----------|--------|
| 1/4" | QA4DP |
| 3/8" | QA6DP |
| 1/2" | QA8DP |
| 3/4" | QA12DP |
| 1" | QA16DP |

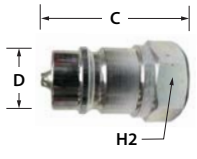

NIPPLE

| BODY SIZE | THREAD SIZE | STEEL | DIMENSIONS (IN) | | |
|-----------|-----------------------------|-------------|-----------------|------|------|
| | | | C | D | H2 |
| 1/4" | 1/4" - Female - NPT | QAN44FP | 1.51 | 0.47 | 0.75 |
| 3/8" | 3/8" - Female - NPT | QAN66FP | 1.54 | 0.68 | 0.87 |
| 1/2" | 1/2" - Female - NPT | QAN88FP | 2.60 | 1.50 | 1.06 |
| 3/4" | 3/4" - Female - NPT | QAN1212FP | 2.17 | 1.14 | 1.34 |
| 1" | 1" - Female - NPT | QAN1616FP | 2.60 | 1.35 | 1.61 |
| 1-1/4" | 1-1/4" - Female - NPT | QAN2020FP | 2.88 | 1.77 | 1.97 |
| 1-1/2" | 1-1/2" - Female - NPT | QAN2424FP | 3.27 | 2.16 | 2.36 |
| 2" | 2" - Female - NPT | QAN3232FP | 3.94 | 2.56 | 2.95 |
| 1/4" | 9/16" - 18 - Female - ORB | QAN46FOB | 1.51 | 0.47 | 0.75 |
| 3/8" | 9/16" - 18 - Female - ORB | QAN66FOB | 1.54 | 0.68 | 0.87 |
| 1/2" | 3/4" - 16 - Female - ORB | QAN88FOB | 2.60 | 1.50 | 1.06 |
| 1/2" | 7/8" 14 - Female - ORB | QAC810FOB | 2.01 | 0.81 | 1.06 |
| 3/4" | 1-1/16" - 12 - Female - ORB | QAN1212FOB | 2.17 | 1.14 | 1.34 |
| 1" | 1-5/16" - 12 - Female - ORB | QAN1616FOB | 2.60 | 1.35 | 1.61 |
| 1/4" | 1/4" - Female - BSPP | QAN44FBSP | 1.51 | 0.47 | 0.75 |
| 3/8" | 3/8" - Female - BSPP | QAN66FBSP | 1.54 | 0.68 | 0.87 |
| 1/2" | 1/2" - Female - BSPP | QAN88FBSP | 2.60 | 1.50 | 1.06 |
| 3/4" | 3/4" - Female - BSPP | QAN1212FBSP | 2.17 | 1.14 | 1.34 |
| 1" | 1" - Female - BSPP | QAN1616FBSP | 2.60 | 1.35 | 1.61 |



DUST CAP FOR NIPPLE

| BODY SIZE | RUBBER |
|-----------|--------|
| 1/4" | QA4DC |
| 3/8" | QA6DC |
| 1/2" | QA8DC |
| 3/4" | QA12DC |
| 1" | QA16DC |

QB Series - ISO B

Coupler



Nipple



Features

- Poppet valve
- Steel seals / PTFE Back-up ring
- Brass / 30455 Viton seals / PTFE Back-up rings
- -22°F to +250°F (-30°C to +125°C)
- Connection: Sleeve Retraction
- Disconnection: Sleeve Retraction
- Connect under pressure: Not Allowed

Applications

- Agricultural
- Industrial
- Mobile Equipment
- Transportation
- Oil & Gas

Interchange

- ISO 7241 - B
- Parker 60
- Eaton FD45
- Faster HNV
- Stucchi IRB/RBO/IRBX
- Dixon H

MAX WORKING PRESSURE (PSI)

| BODY SIZE | STEEL | BRASS | 304 SS |
|-----------|-------|-------|--------|
| 1/8" | 7,200 | 3,000 | 3,500 |
| 1/4" | 6,500 | 3,000 | 3,500 |
| 3/8" | 4,350 | 2,500 | 3,500 |
| 1/2" | 5,000 | 2,500 | 3,500 |
| 3/4" | 3,625 | 2,000 | 3,000 |
| 1" | 4,350 | 1,500 | 2,000 |
| 1-1/4" | 2,500 | 1,000 | 2,000 |
| 1-1/2" | 2,500 | 1,000 | 1,500 |
| 2" | 1,500 | 700 | 1,000 |

BECAUSE WE CONTINUALLY EXAMINE WAYS TO IMPROVE OUR PRODUCTS, WE RESERVE THE RIGHT TO ALTER SPECIFICATIONS WITHOUT NOTICE.

QB Series - ISO B - Coupler

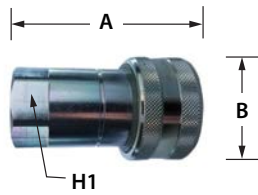

COUPLER

| BODY SIZE | THREAD SIZE | STEEL | BRASS | 304 STAINLESS | DIMENSIONS (IN) | | |
|-----------|----------------------------|------------|--------------|---------------|-----------------|------|------|
| | | | | | A | B | H1 |
| 1/8" | 1/8" - Female - NPT | QBC22FP | QBC22FP-BR | QBC22FP-S4 | 1.98 | 0.91 | 0.71 |
| 1/4" | 1/4" - Female - NPT | QBC44FP | QBC44FP-BR | QBC44FP-S4 | 2.20 | 1.10 | 0.75 |
| 3/8" | 3/8" - Female - NPT | QBC66FP | QBC66FP-BR | QBC66FP-S4 | 2.52 | 1.38 | 0.94 |
| 1/2" | 1/2" - Female - NPT | QBC88FP | QBC88FP-BR | QBC88FP-S4 | 2.81 | 1.73 | 1.18 |
| 3/4" | 3/4" - Female - NPT | QBC1212FP | QBC1212FP-BR | QBC1212FP-S4 | 3.50 | 2.05 | 1.42 |
| 1" | 1" - Female - NPT | QBC1616FP | QBC1616FP-BR | QBC1616FP-S4 | 4.17 | 2.44 | 1.61 |
| 1-1/4" | 1-1/4" - Female - NPT | QBC2020FP | -- | -- | 4.50 | 2.60 | 2.38 |
| 1-1/2" | 1-1/2" - Female - NPT | QBC2424FP | -- | -- | 4.81 | 3.00 | 2.63 |
| 2" | 2" - Female - NPT | QBC3232FP | -- | -- | 5.59 | 4.13 | 3.50 |
| 1/4" | 9/16" -18 - Female - ORB | QBC46FOB | -- | -- | 2.36 | 1.10 | 0.75 |
| 3/8" | 9/16" - Female - ORB | QBC66FOB | -- | -- | 2.52 | 1.38 | 0.94 |
| 3/8" | 3/4" -16 - Female - ORB | QBC68FOB | -- | -- | 2.64 | 1.38 | 0.98 |
| 1/2" | 7/8" -14 - Female - ORB | QBC810FOB | -- | -- | 2.81 | 1.73 | 1.18 |
| 3/4" | 1-1/16" -12 - Female - ORB | QBC1212FOB | -- | -- | 3.50 | 2.05 | 1.42 |
| 1" | 1-5/16" -12 - Female - ORB | QBC1616FOB | -- | -- | 4.17 | 2.44 | 1.61 |



DUST PLUG FOR COUPLER

| BODY SIZE | RUBBER |
|-----------|--------|
| 1/8" | QB2DP |
| 1/4" | QB4DP |
| 3/8" | QB6DP |
| 1/2" | QB8DP |
| 3/4" | QB12DP |
| 1" | QB16DP |

BECAUSE WE CONTINUALLY EXAMINE WAYS TO IMPROVE OUR PRODUCTS, WE RESERVE THE RIGHT TO ALTER SPECIFICATIONS WITHOUT NOTICE.

QB Series - ISO B - Nipple

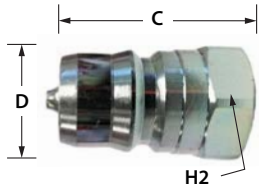

NIPPLE

| BODY SIZE | THREAD SIZE | STEEL | BRASS | 304 STAINLESS | DIMENSIONS (IN) | | |
|-----------|----------------------------|------------|--------------|---------------|-----------------|------|------|
| | | | | | C | D | H2 |
| 1/8" | 1/8" - Female - NPT | QBN22FP | QBN22FP-BR | QBN22FP-S4 | 1.24 | 0.43 | 0.67 |
| 1/4" | 1/4" - Female - NPT | QBN44FP | QBN44FP-BR | QBN44FP-S4 | 1.38 | 0.56 | 0.75 |
| 3/8" | 3/8" - Female - NPT | QBN66FP | QBN66FP-BR | QBN66FP-S4 | 1.54 | 0.75 | 0.87 |
| 1/2" | 1/2" - Female - NPT | QBN88FP | QBN88FP-BR | QBN88FP-S4 | 1.73 | 1.24 | 1.34 |
| 3/4" | 3/4" - Female - NPT | QBN1212FP | QBN1212FP-BR | QBN1212FP-S4 | 2.17 | 1.24 | 1.34 |
| 1" | 1" - Female - NPT | QBN1616FP | QBN1616FP-BR | QBN1616FP-S4 | 2.60 | 1.49 | 1.61 |
| 1-1/4" | 1-1/4" - Female - NPT | QBN2020FP | -- | -- | 4.25 | | 2.38 |
| 1-1/2" | 1-1/2" - Female - NPT | QBN2424FP | -- | -- | 4.96 | 1.75 | 2.30 |
| 2" | 2" - Female - NPT | QBN3232FP | -- | -- | 5.59 | 2.49 | 3.50 |
| 1/4" | 9/16" -18 - Female - ORB | QBN46FOB | -- | -- | 1.54 | 0.56 | 0.75 |
| 3/8" | 9/16" -18 - Female - ORB | QBN66FOB | -- | -- | 1.54 | 0.75 | 0.87 |
| 3/8" | 3/4" -16 - Female - ORB | QBN68FOB | -- | -- | 1.77 | 0.75 | 1.06 |
| 1/2" | 7/8" -14 - Female - ORB | QBN810FOB | -- | -- | 1.97 | 0.93 | 1.18 |
| 3/4" | 1-1/16" -12 - Female - ORB | QBN1212FOB | -- | -- | 2.17 | 1.24 | 1.34 |
| 1" | 1-5/16" -12 - Female - ORB | QBN1616FOB | -- | -- | 2.60 | 1.49 | 1.61 |



DUST CAP FOR NIPPLE

| BODY SIZE | RUBBER |
|-----------|--------|
| 1/8" | QB2DC |
| 1/4" | QB4DC |
| 3/8" | QB6DC |
| 1/2" | QB8DC |
| 3/4" | QB12DC |
| 1" | QB16DC |

BECAUSE WE CONTINUALLY EXAMINE WAYS TO IMPROVE OUR PRODUCTS, WE RESERVE THE RIGHT TO ALTER SPECIFICATIONS WITHOUT NOTICE.

QST Series - Straight Through

Coupler



Male

Female

Nipple



Male

Female

Features

- -22°F to +250°F (-30°C to +125°C)
- Connection: Sleeve Retraction
- Disconnection: Sleeve Retraction
- Connect Under Pressure: Not Allowed

Applications

- High pressure water and steam washers
- Other applications where high flow is necessary

Interchange

- Parker ST
- Foster FST
- Hansen ST
- Dixon E

PERFORMANCE SPECIFICATIONS (PSI)

| BODY SIZE | 304 STAINLESS | BRASS |
|-----------|---------------|-------|
| 1/4" | 6,000 | 5,000 |
| 3/8" | 5,000 | 4,000 |
| 1/2" | 5,000 | 3,000 |
| 3/4" | 3,000 | 1,700 |
| 1" | 1,700 | 1,700 |
| 1-1/4" | 2,000 | 1,700 |
| 1-1/2" | 2,000 | 1,400 |
| 2" | 2,000 | 1,400 |

BECAUSE WE CONTINUALLY EXAMINE WAYS TO IMPROVE OUR PRODUCTS, WE RESERVE THE RIGHT TO ALTER SPECIFICATIONS WITHOUT NOTICE.

QST Series - Straight Through - Coupler

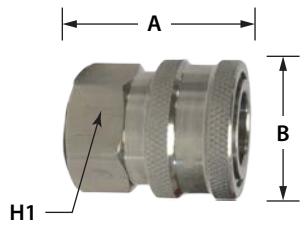

COUPLER - FEMALE

| BODY SIZE | THREAD SIZE | 304 STAINLESS | BRASS | DIMENSIONS (IN) | | |
|-----------|-----------------------|---------------|---------------|-----------------|------|------|
| | | | | A | B | H1 |
| 1/4" | 1/4" - Female - NPT | QSTC44FP-S4 | QSTC44FP-BR | 1.40 | 0.96 | 0.81 |
| 3/8" | 3/8" - Female - NPT | QSTC66FP-S4 | QSTC66FP-BR | 1.60 | 1.13 | 1.00 |
| 1/2" | 1/2" - Female - NPT | QSTC88FP-S4 | QSTC88FP-BR | 1.96 | 1.27 | 1.13 |
| 3/4" | 3/4" - Female - NPT | QSTC1212FP-S4 | QSTC1212FP-BR | 2.10 | 1.65 | 1.50 |
| 1" | 1" - Female - NPT | QSTC1616FP-S4 | QSTC1616FP-BR | 2.36 | 2.02 | 1.75 |
| 1-1/4" | 1-1/4" - Female - NPT | -- | QSTC2020FP-BR | 2.36 | 2.59 | 2.25 |
| 1-1/2" | 1-1/4" - Female - NPT | -- | QSTC2424FP-BR | 2.89 | 3.18 | 2.75 |
| 2" | 2" - Female - NPT | -- | QSTC3232FP-BR | 3.00 | 4.04 | 3.50 |

* Add suffix - LS for locking sleeve

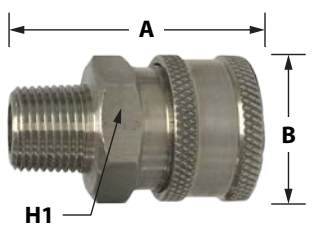

COUPLER - MALE

| BODY SIZE | THREAD SIZE | 304 STAINLESS | BRASS | DIMENSIONS (IN) | | |
|-----------|-------------------|---------------|---------------|-----------------|------|------|
| | | | | A | B | H1 |
| 1/4" | 1/4" - Male - NPT | QSTC44MP-S4 | QSTC44MP-BR | 1.66 | 0.96 | 0.81 |
| 3/8" | 3/8" - Male - NPT | QSTC66MP-S4 | QSTC66MP-BR | 1.70 | 1.13 | 1.00 |
| 1/2" | 1/2" - Male - NPT | QSTC88MP-S4 | QSTC88MP-BR | 2.00 | 1.27 | 1.13 |
| 3/4" | 3/4" - Male - NPT | QSTC1212MP-S4 | QSTC1212MP-BR | 2.24 | 1.65 | 1.50 |
| 1" | 1" - Male - NPT | QSTC1616MP-S4 | QSTC1616MP-BR | 2.61 | 2.02 | 1.75 |

* Add suffix - LS for locking sleeve

BECAUSE WE CONTINUALLY EXAMINE WAYS TO IMPROVE OUR PRODUCTS, WE RESERVE THE RIGHT TO ALTER SPECIFICATIONS WITHOUT NOTICE.

QST Series - Straight Through - Nipple

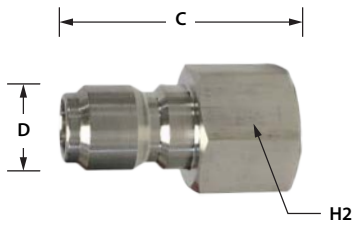

NIPPLE - FEMALE

| BODY SIZE | THREAD SIZE | 304 STAINLESS | BRASS | DIMENSIONS (IN) | | |
|-----------|-----------------------|---------------|---------------|-----------------|---|------|
| | | | | C | D | H2 |
| 1/4" | 1/4" - Female - NPT | QSTN44FP-S4 | QSTN44FP-BR | 1.47 | | 0.69 |
| 3/8" | 3/8" - Female - NPT | QSTN66FP-S4 | QSTN66FP-BR | 1.60 | | 0.88 |
| 1/2" | 1/2" - Female - NPT | QSTN88FP-S4 | QSTN88FP-BR | 1.82 | | 1.00 |
| 3/4" | 3/4" - Female - NPT | QSTN1212FP-S4 | QSTN1212FP-BR | 2.05 | | 1.19 |
| 1" | 1" - Female - NPT | QSTN1616FP-S4 | QSTN1616FP-BR | 2.36 | | 1.50 |
| 1-1/4" | 1-1/4" - Female - NPT | -- | QSTN2020FP-BR | 2.47 | | 2.00 |
| 1-1/2" | 1-1/4" - Female - NPT | -- | QSTN2424FP-BR | 2.74 | | 2.25 |
| 2" | 2" - Female - NPT | -- | QSTN3232FP-BR | 3.00 | | 2.63 |

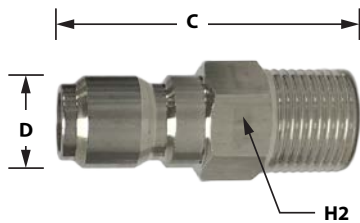

NIPPLE - MALE

| BODY SIZE | THREAD SIZE | 304 STAINLESS | BRASS | DIMENSIONS (IN) | | |
|-----------|-------------------|---------------|---------------|-----------------|---|------|
| | | | | C | D | H2 |
| 1/4" | 1/4" - Male - NPT | QSTN44MP-S4 | QSTN44MP-BR | 1.50 | | 0.56 |
| 3/8" | 3/8" - Male - NPT | QSTN66MP-S4 | QSTN66MP-BR | 1.69 | | 0.69 |
| 1/2" | 1/2" - Male - NPT | QSTN88MP-S4 | QSTN88MP-BR | 1.91 | | 0.88 |
| 3/4" | 3/4" - Male - NPT | QSTN1212MP-S4 | QSTN1212MP-BR | 2.25 | | 1.06 |
| 1" | 1" - Male - NPT | QSTN1616MP-S4 | QSTN1616MP-BR | 2.45 | | 1.38 |

BECAUSE WE CONTINUALLY EXAMINE WAYS TO IMPROVE OUR PRODUCTS, WE RESERVE THE RIGHT TO ALTER SPECIFICATIONS WITHOUT NOTICE.

QWB Series - Water Blast

Coupler



Nipple



Features

- -40°F to +158°F (-40°C to +70°C)
- Connection: Sleeve Retraction
- Disconnection: Sleeve Retraction
- Connection Under Pressure: Not Allowed
- Max Working Pressure: 10,000 PSI

Applications

- High pressure water blasting
- Bridge/concrete repair
- Ship yards

Interchange

- Parker WB
- Eaton FD69
- Snap-Tite 56
- Dixon EA

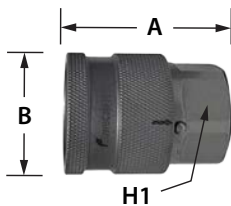

COUPLER

| BODY SIZE | THREAD SIZE | STEEL | DIMENSIONS (IN) | | |
|-----------|-------------|----------|-----------------|------|------|
| | | | A | B | H1 |
| 1/2" | 3/8" NPT | QWBC86FP | 2.20 | 1.61 | 1.26 |
| 1/2" | 1/2" NPT | QWBC88FP | 2.20 | 1.61 | 1.26 |

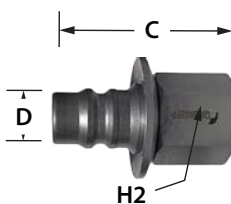

NIPPLE

| BODY SIZE | THREAD SIZE | STEEL | DIMENSIONS (IN) | | |
|-----------|-------------|----------|-----------------|------|------|
| | | | C | D | H2 |
| 1/2" | 3/8" NPT | QWBN86FP | 2.35 | 0.50 | 1.06 |
| 1/2" | 1/2" NPT | QWBN88FP | 2.35 | 0.50 | 1.06 |

BECAUSE WE CONTINUALLY EXAMINE WAYS TO IMPROVE OUR PRODUCTS, WE RESERVE THE RIGHT TO ALTER SPECIFICATIONS WITHOUT NOTICE.

QWS Series - Water Blast

Coupler



Nipple



Features

- 316 stainless steel
- Screw Type
- Non-Valve
- -40°F to +158°F (-40°C to +70°C)
- Nitrile Seals

Applications

- Waterblast
- Water Jetting
- Bridge/Concrete Repair
- Shipyards

Interchange

- Dixon 4TDF4-SS
- SPIR Star CQD
- Jet Stream Screw Type

COUPLER

| BODY SIZE | THREAD SIZE | COUPLER PART NUMBER | MAXIMUM WORKING PRESSURE (PSI) | DIMENSIONS (IN) | | |
|-----------|-------------|---------------------|--------------------------------|-----------------|------|------|
| | | | | A | B | H1 |
| 1/2" | 3/8" NPT | QWSC86FP-S6 | 15,000 | 2.91 | 1.85 | 1.13 |
| 1/2" | 1/2" NPT | QWSC88FP-S6 | 15,000 | 2.91 | 1.85 | 1.13 |

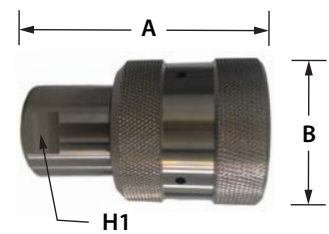

NIPPLE

| BODY SIZE | THREAD SIZE | NIPPLE PART NUMBER | MAXIMUM WORKING PRESSURE (PSI) | DIMENSIONS (IN) | | |
|-----------|-------------|--------------------|--------------------------------|-----------------|------|------|
| | | | | C | D | H2 |
| 1/2" | 3/8" NPT | QWSN86FP-S6 | 15,000 | 2.05 | 0.75 | 1.63 |
| 1/2" | 1/2" NPT | QWSN88FP-S6 | 15,000 | 2.05 | 0.75 | 1.63 |

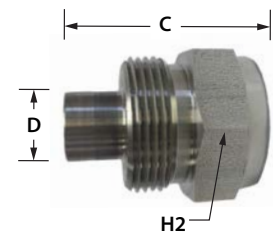

BECAUSE WE CONTINUALLY EXAMINE WAYS TO IMPROVE OUR PRODUCTS, WE RESERVE THE RIGHT TO ALTER SPECIFICATIONS WITHOUT NOTICE.

Hydraulic Profiles

QG Series
(Agricultural)

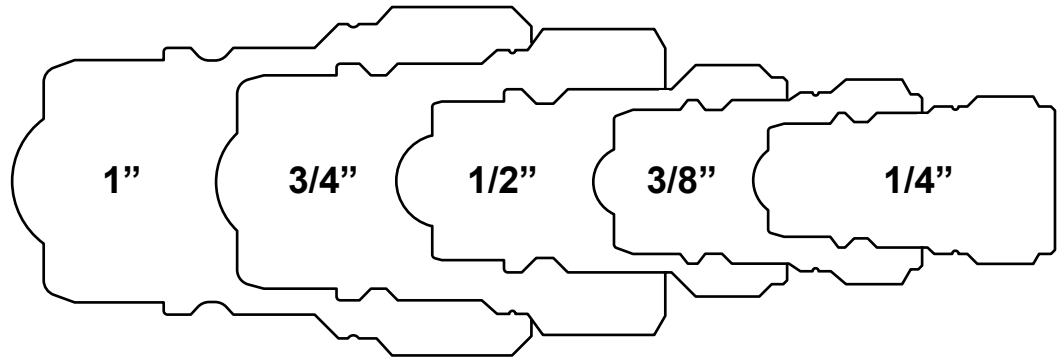

QF Series
(Flat Face 16028)

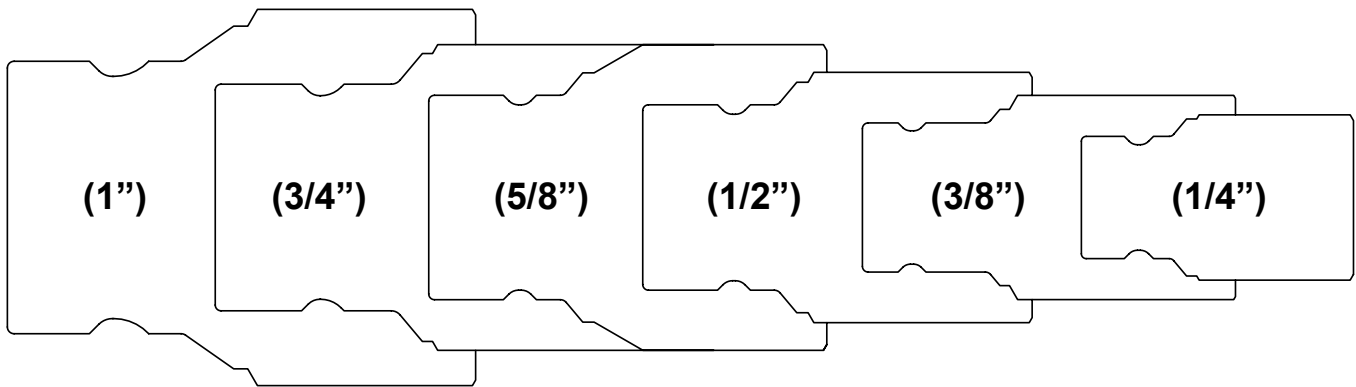

HP Flat Face
Series

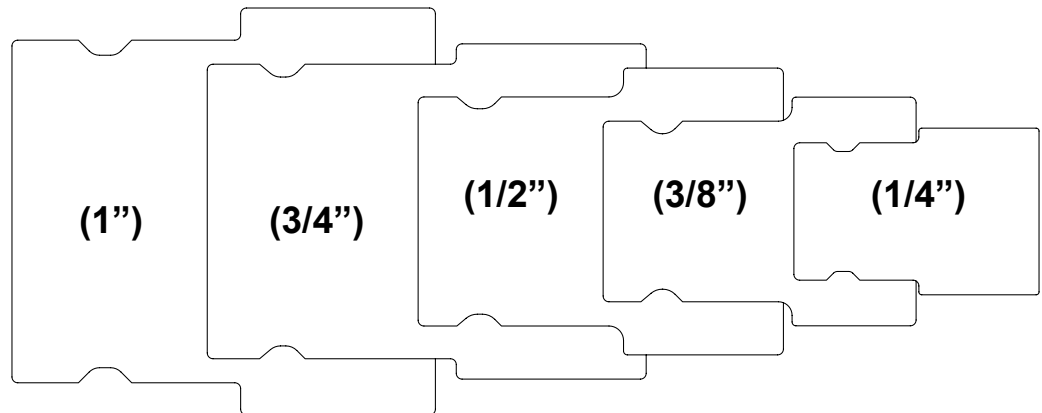

BECAUSE WE CONTINUALLY EXAMINE WAYS TO IMPROVE OUR PRODUCTS, WE RESERVE THE RIGHT TO ALTER SPECIFICATIONS WITHOUT NOTICE.

Hydraulic Profiles

**QWN Series
(Wing Nut)**

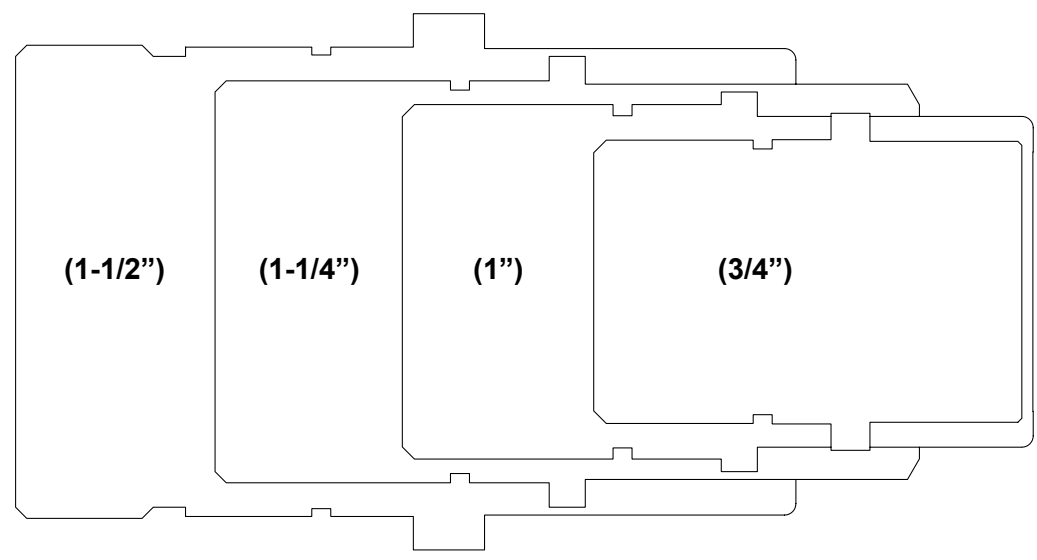

**QJ Series
(Hydraulic Jack)**

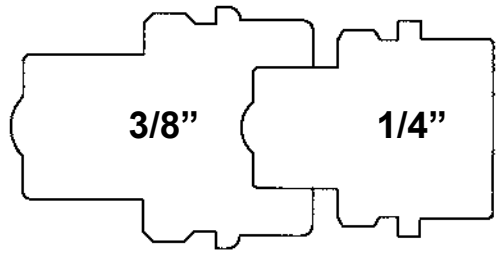

**QT Series
(Diagnostic)**

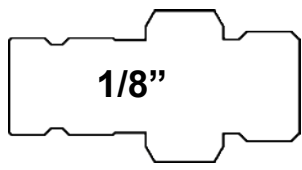

**QH Series
(Snap-Tite H)**

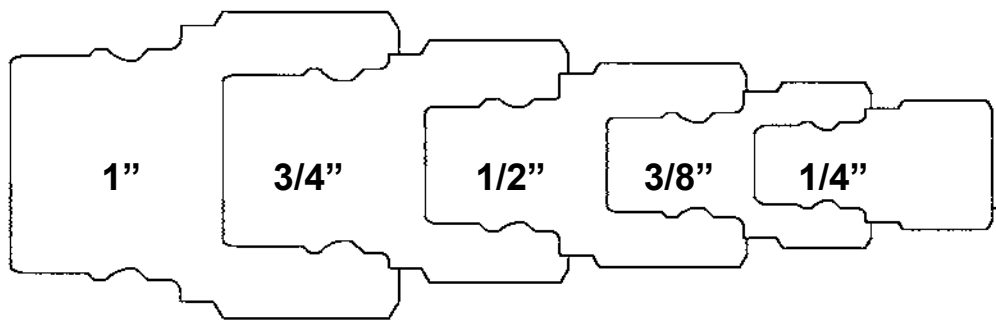

BECAUSE WE CONTINUALLY EXAMINE WAYS TO IMPROVE OUR PRODUCTS, WE RESERVE THE RIGHT TO ALTER SPECIFICATIONS WITHOUT NOTICE.

Hydraulic Profiles

QTE Series
(TEMA)

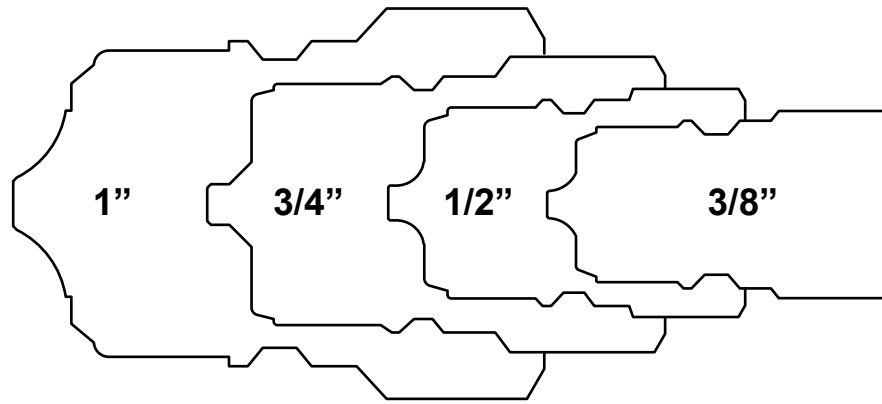

QA Series
(ISO-A)

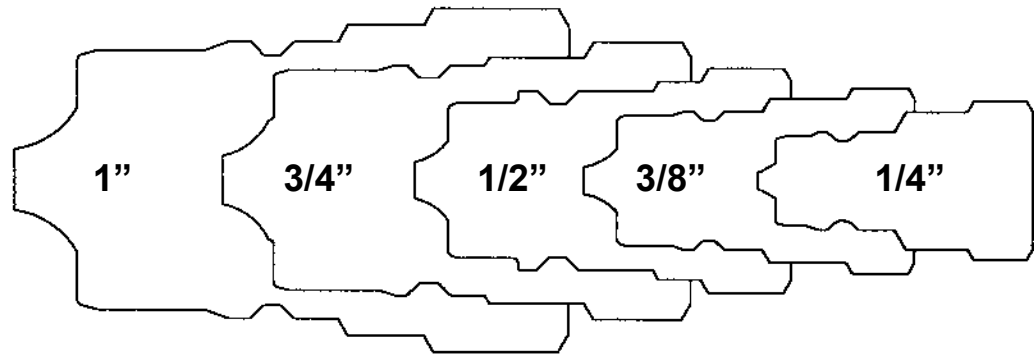

QB Series
(ISO-B)

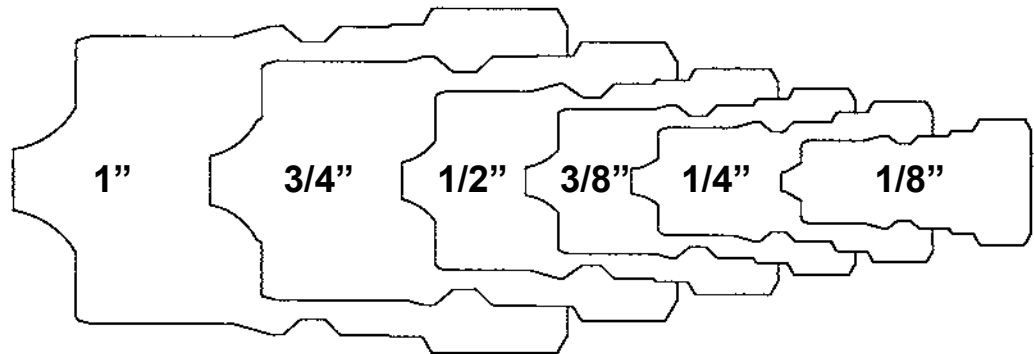

BECAUSE WE CONTINUALLY EXAMINE WAYS TO IMPROVE OUR PRODUCTS, WE RESERVE THE RIGHT TO ALTER SPECIFICATIONS WITHOUT NOTICE.

Hydraulic Profiles

**QST Series
(Straight Through)**

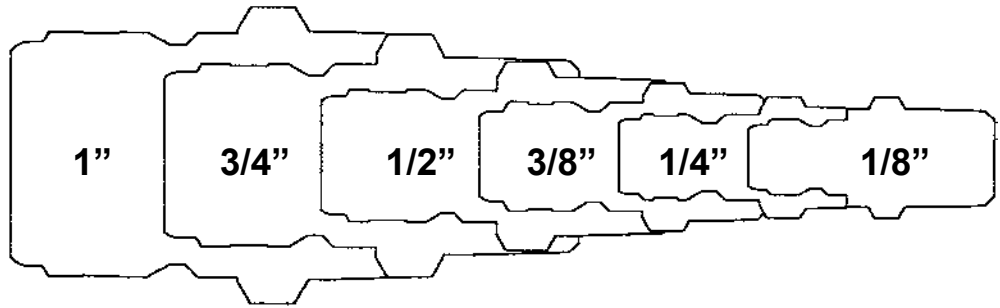

**QWK Series
(Waterblast)**

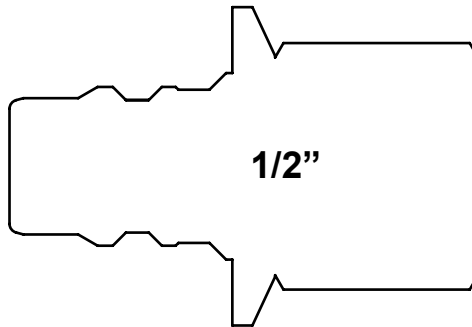

BECAUSE WE CONTINUALLY EXAMINE WAYS TO IMPROVE OUR PRODUCTS, WE RESERVE THE RIGHT TO ALTER SPECIFICATIONS WITHOUT NOTICE.

Hydraulic Quick Disconnect - Interchange Guide

| FORSAFLEX | FASTER | DIXON | AEROQUIP | PARKER | HOLMBURY | STUCCHI | DNP |
|--|-------------|-------------|-----------------|---------|---------------|---------------|---------------------|
| AGRICULTURAL COUPLER - POPPET (PUSH-PULL) | | | | | | | |
| QGPC88FP-P | PV12 NPT F | 4AGF4-PV-PS | | 4250-4P | P12-F-08-N | | |
| AGRICULTURAL COUPLER - POPPET | | | | | | | |
| QGC44FP-P | NV 14 NPT F | 2AGF2-PV | FD42-1001-04-04 | 4050-2P | IA06-F-04N | F. IR 14V NPT | NV-04-04C-NPT |
| QGC66FP-P | NV 38 NPT F | 3AGF3-PV | FD42-1001-06-06 | 4050-3P | IA10-F-06N | F. IR38V NPT | NV-06-06C-NPT |
| QGC88FP-P | ANV12NPTF | 4AGF4-PV | FD76-1001-08-10 | | IA12-F-08N | F. BIR12 NPT | ANV-08-08-C-NPT |
| QGC1212FP-P | NV 34 NPT F | 4AGF4-PV | FD42-1001-12-12 | 4150-5 | IA19-F-12N | F. IR34V NPT | NV-12-12C-NPT |
| QGC1616FP-P | NV 1 NPT F | 4AGF4-PV | FD42-1001-16-16 | 4050-6P | IA25-F-16N | F. IR100V NPT | NV-16-16C-NPT |
| AGRICULTURAL NIPPLE - POPPET | | | | | | | |
| QGN44FP-P | NV 14 NPT M | AG2F2-PV | FD42-1002-04-04 | 4010-2P | IA06-M-04N | M. IR14V NPT | NV-04-04N-NPT |
| QGN66FP-P | NV 38 NPT M | AG3F3-PV | FD42-1002-06-06 | 4010-3P | IA10-M-06N | M. IR38V NPT | NV-06-06N-NPT |
| QGN88FP-P | ANV12NPTM | AG4F4-PV | FD76-1002-08-10 | 8010-4P | IA12-M-08N | M. BIR12 NPT | ANV-08-08-N-NPT |
| QGN1212FP-P | NV 34 NPT M | AG6F6-PV | FD42-1002-12-12 | 4110-5 | IA19-M-12N | M. IR34V NPT | NV-12-12N-NPT |
| QGN1616FP-P | NV 1 NPT M | AG8F8-PV | FD42-1002-16-16 | 4010-6P | IA25-M-16N | M. IR100V NPT | NV-16-16N-NPT |
| AGRICULTURAL NIPPLE - BALL (PUSH-PULL) | | | | | | | |
| QGPC88FP-B | | 4AGF4-PS | | 4250-4 | P12-F-08-N-B | | |
| AGRICULTURAL COUPLER - BALL | | | | | | | |
| QGC44FP-B | NS14NPTF | 2AGF2 | | 4050-2 | DINB06-F-04N | F IR 14 NPT | NS-04-04-C-NPT |
| QGC66FP-B | NS38NPTF | 3AGF3 | | 4050-3 | P10-F-06N B | F. IR 38 NPT | NS-06-06-C-NPT |
| QGC88FP-B | NS12NPTF | 4AGF4 | | 4050-4 | DINB12-F-08N | F IR 12 NPT | NS-08-08-C-NPT |
| AGRICULTURAL NIPPLE - BALL | | | | | | | |
| QGN44FP-B | NS14NPTM | AG2F2 | | 4010-2 | DINB06-M-04N | M IR 14 NPT | NS-04-04-N-NPT |
| QGN66FP-B | NS38NPTM | AG3F3 | | 4010-3 | DINB10-M-06N | M IR 38 NPT | NS-06-06-N-NPT |
| QGN88FP-B | NS12NPTM | AG4F4 | | 4010-4 | DINB12-MS-08N | M IR 12 NPT | NS-08-08-N-NPT |
| BOP COUPLER ISO-B | | | | | | | |
| QBC88FP-BOP | HNVFR12NPTF | 4HF4-BOP | 4HFR26 | | | | HNV-BOP-08-08-C-NPT |
| QBC1212FP-BOP | HNVFR34NPTF | 6HF6-BOP | 6HFR31 | | | | HNV-BOP-12-12-C-NPT |
| QBC1616FP-BOP | HNVFR1NPTF | 8HF8-BOP | 8HFR36 | | | | HNV-BOP-16-16-C-NPT |

Hydraulic Quick Disconnect - Interchange Guide

| FORSAFLEX | FASTER | DIXON | AEROQUIP | PARKER | HOLMBURY | STUCCHI | DNP |
|--------------------------------------|----------------|-----------|-----------------|---------------|----------------|----------------|---------------------|
| BOP NIPPLE ISO-B | | | | | | | |
| QBN88FP-BOP | HNVFR12NPTM | H4F4-BOP | 4KFR26 | | | | HNV-BOP-08-08-N-NPT |
| QBN1212FP-BOP | HNVFR34NPTM | H6F6-BOP | 6KFR31 | | | | HNV-BOP-12-12-N-NPT |
| QBN1616FP-BOP | HNVFR1NPTM | H8F8-BOP | 8KFR36 | | | | HNV-BOP-16-16-N-NPT |
| BOP COUPLER Q75 | | | | | | | |
| Q75C1212FP-BOP | OGVFR12-34NPSF | 6WSF6-BOP | | 75C12-12F-DBP | LC19-F-12N-BOP | VOFX-811201051 | VFF-HD-BOP1212C-NPT |
| Q75C1616FP-BOP | OGVFR16-1NPSF | 8WSF8-BOP | | 75C16-16F-DBP | LC25-F-16N-BOP | VOFX-811201053 | VFF-HD-BOP1616C-NPT |
| BOP NIPPLE Q75 | | | | | | | |
| Q75N1212FP-BOP | OGVFR12-34NPSM | WS6F6-BOP | | 75N12-12F-DBP | LC19-M-12N-BOP | VOFX-811201050 | VFF-HD-BOP1212N-NPT |
| Q75N1616FP-BOP | OGVFR16-1NPSM | WS8F8-BOP | | 75N16-16F-DBP | LC25-M-16N-BOP | VOFX-811201052 | VFF-HD-BOP1616N-NPT |
| FLAT FACE COUPLER (ISO-16028) | | | | | | | |
| Q75N1212FP-BOP | OGVFR12-34NPSM | WS6F6-BOP | | 75N12-12F-DBP | LC19-M-12N-BOP | VOFX-811201050 | VFF-HD-BOP1212N-NPT |
| Q75N1616FP-BOP | OGVFR16-1NPSM | WS8F8-BOP | | 75N16-16F-DBP | LC25-M-16N-BOP | VOFX-811201052 | VFF-HD-BOP1616N-NPT |
| QFFC68FP | FFH0612NPTF | 3HTF4 | FD89-1001-06-08 | FF371-8FP | HQ10-F-08N | FA9 1/2 NPT | FF-GP-06-08-C-NPT |
| QFFC88FP | FFH0812NPTF | 4HTF4 | FD89-1001-08-08 | FEM-501-8FP | HQ12-F-08N | FA13 1/2 NPT | FF-GP-08-08-C-NPT |
| QFFC812FP | FFH0834NPTF | 4HTF6 | FD89-1001-08-12 | FEM-501-12FP | | | |
| QFFC1212FP | FFH1234NPTF | 6HTF6 | FD89-1001-12-12 | FEM-751-12FP | HQ19-F-12N | FA17 3/4 NPT | FF-GP-12-12-C-NPT |
| QFFC1216FP | FFH121NPTF | 6HTF8 | FD89-1001-12-16 | FEM-751-16FP | HQ19-F-16N | FA17 1 NPT | FF-GP-12-16-C-NPT |
| QFFC1616FP | FFH161NPTF | 8HTF8 | FD89-1001-16-16 | FEM-1001-16FP | | | |
| QFFC66FOB | FFH0638SAEF | 3HTOF3 | FD89-1005-06-06 | FEM-371-6FO | HQ10-F-06S | FA9 3/8 SAE | FF-GP-06-06-C-SAE |
| QFFC68FOB | FFH0612SAEF | 3HTOF4 | FD89-1005-06-08 | FEM-371-8FO | HQ10-F-08S | FA9 1/2 SAE | FF-GP-06-08-C-SAE |
| QFFC1012FOB | FFH1034SAEF | 5HTOF6 | FD89-1001-10-12 | FEM-621-12FP | HQ16-F-12N | FA15 3/4 NPT | FF-GP-10-12-C-NPT |
| QFFC1212FOB | FFH1234SAEF | 6HTOF6 | FD89-1005-12-12 | FEM-751-12FO | HQ16-F-12S | FA15 3/4 SAE | FF-GP-12-12-C-SAE |
| QFFC1616FOB | FFH161SAEF | 8HTOF8 | FD89-1005-16-16 | FEM-1001-16FO | HQ19-F-16S | FA17 1 SAE | FF-GP-16-16-C-SAE |

Hydraulic Quick Disconnect - Interchange Guide

| FORSAFLEX | FASTER | DIXON | AEROQUIP | PARKER | HOLMBURY | STUCCHI | DNP |
|--|--------------|----------|-----------------|---------------|-------------|-----------------|-------------------|
| FLAT FACE NIPPLE (ISO-16028) | | | | | | | |
| QFFN44FP | FFH0414NPTM | HT2F2 | FD89-1002-04-04 | FEM-252-4FP | HQ10-M-08N | M. FIRG 14 NPT | FF-GP-04-04-N-NPT |
| QFFN66FP | FFH0638NPTM | HT3F3 | FD89-1002-06-06 | FF-372-6FP | HQ10-M-06N | M.A9 3/8 NPT | FF-GP-06-06-N-NPT |
| QFFN68FP | FFH0612NPTM | HT3F4 | FD89-1002-06-08 | FF-372-8FP | HQ10-M-08N | M.A9 1/2 NPT | FF-GP-06-08-N-NPT |
| QFFN88FP | FFH0812NPTM | HT4F4 | FD89-1002-08-08 | FEM-502-8FP | HQ12-M-08N | M.A13 1/2 NPT | FF-GP-08-08-N-NPT |
| QFFN812FP | FFH0834NPTM | HT4F6 | FD89-1002-08-12 | FEM-502-12FP | HQ12-M-12N | M. A13 3/4 NPT | FF-GP-08-12-N-NPT |
| QFFN1212FP | FFH1234NPTM | HT6F6 | FD89-1002-12-12 | FEM-752-12FP | HQ19-M-12N | M.A17 3/4 NPT | FF-GP-12-12-N-NPT |
| QFFN1216FP | FFH121NPTM | HT6F8 | FD89-1002-12-16 | FEM-752-16FP | HQ19-M-16N | M.A17 1 NPT | FF-GP-12-16-N-NPT |
| QFFN1616FP | FFH161NPTM | HT8F8 | FD89-1002-16-16 | FEM-1002-16FP | HQ25-M-16N | M A21 1 NPT | FF-GP-16-16-N-NPT |
| QFFN66FOB | FFH0638SAEM | HT3OF3 | FD89-1004-06-06 | FEM-372-6FO | HQ10-M-06S | M.A9 3/8 SAE | FF-GP-06-06-N-SAE |
| QFFN68FOB | FFH0612SAEM | HT3OF4 | FD89-1004-06-08 | FEM-372-8FO | HQ10-M-08S | M.A9 1/2 SAE | FF-GP-06-08-N-SAE |
| QFFN1012FOB | FFH1034SAEM | HT5OF6 | FD89-1002-10-12 | FEM-622-12FP | HQ16-M-12N | M.A15 3/4 NPT | FF-GP-10-12-N-SAE |
| QFFN1212FOB | FFH1234SAEM | HT6OF6 | FD89-1004-12-12 | FEM-752-12FO | HQ16-M-12S | M.A15 3/4 SAE | FF-GP-12-12-N-SAE |
| QFFN1616FOB | FFH161SAEM | HT8OF8 | FD89-1004-16-16 | FEM-1002-16FO | HQ19-F-16S | F.A17 1 SAE | FF-GP-16-16-N-SAE |
| FLAT FACE NIPPLE-CONNECT UNDER PRESSURE (ISO-16028) | | | | | | | |
| QFZN66FP | 3FFH0638NPTM | | 10FFPCUP37 | FEC-372-6FP | HCP10-M-06N | M.APM9 3/8 NPT | FFK-06-06-N-NPT |
| QFZN88FP | 3FFH0812NPTM | HTE4F4 | 12FFPCUP50 | FEC-502-8FP | HCP12-M-08N | M.APM13 1/2 NPT | FFK-08-08-N-NPT |
| QFZN812FP | 3FFH0834NPTM | HTE4F6 | 12FFPCUP75 | FEC-502-12FO | HCP12-M-12N | M.APM13 3/4-NPT | FFK-08-12-N-NPT |
| QFZN68FOB | 3FFI3812SAEM | HTE3OF4 | 10FFPCUP56UN | FEC-372-8FO | HCP10-M-08S | M.APM9 1/2 SAE | FFK-06-08-N-SAE |
| QFZN88FOB | 3FFH0812SAEM | HTE4OF4 | 12FFPCUP75UN | FEC-502-8FO | HCP12-M-08S | M.APM13 1/2 SAE | FFK-08-08-N-SAE |
| VEP- THREADED TOGETHER FLAT FACE COUPLER | | | | | | | |
| QVEPC88FP | | 4VEPF4 | FD96-1001-08-08 | FET-501-8FP | HFT12-F-08N | F.VEP13 1/2 NPT | FSI-08-08-F-NPT |
| QVEPC2020FP | | 10VEPF10 | FD96-1001-20-20 | | HFT25-F-20N | F.VEP21 114 NPT | FSI-20-20-F-NPT |
| QVEPC2424FP | | 12VEPF12 | FD96-1001-24-24 | FET-1501-24FP | HFT32-F-24N | F.VEP30 112 NPT | FSI-24-24-F-NPT |
| QVEPC88FOB | | 4VEPOF4 | FD96-1005-08-08 | FET-501-12FO | HFT12-F-08S | F.VEP13 3/4 SAE | FSI-08-08-F-SAE |
| QVEPC1212FOB | | 6VEPOF6 | FD96-1005-12-12 | FET-751-12FO | HFT16-F-12S | F.VEP15 3/4 SAE | FSI-12-12-F-SAE |
| QVEPC1616FOB | | 8VEPOF8 | FD96-1005-16-16 | FET-1001-16FO | HFT19-F-16S | F.VEP17 1 SAE | FSI-16-16-F-SAE |
| VEP- THREADED TOGETHER FLAT FACE NIPPLE | | | | | | | |
| QVEPN88FP | | VEP4F4 | FD96-1002-08-08 | FET-502-8FP | HFT12-M-08N | M.VEP13 1/2 NPT | FSI-08-08-M-NPT |
| QVEPN2020FP | | VEP10F10 | FD96-1002-20-20 | | HFT25-M-20N | M.VEP21 114 NPT | FSI-20-20-M-NPT |
| QVEPN2424FP | | VEP12F12 | FD96-1002-24-24 | FET-1502-24FP | HFT32-M-24N | M.VEP30 112 NPT | FSI-24-24-M-NPT |
| QVEPN88FOB | | VEP4OF4 | FD96-1004-08-08 | FET-502-8FO | HFT12-M-08S | M.VEP13 1/2 SAE | FSI-08-08-M-SAE |
| QVEPN1212FOB | | VEP6OF6 | FD96-1004-12-12 | FET-752-12FO | HFT16-M-12S | M.VEP15 3/4 SAE | FSI-12-12-M-SAE |
| QVEPN1616FOB | | VEP8OF8 | FD96-1004-16-16 | FET-1002-16FO | HFT19-M-16S | M.VEP17 1 SAE | FSI-16-16-M-SAE |

Hydraulic Quick Disconnect - Interchange Guide

| FORSAFLEX | FASTER | DIXON | AEROQUIP | PARKER | HOLMBURY | STUCCHI | DNP |
|---|------------------|----------|-----------------|---------|--------------|--------------------|-------------------|
| WING NUT COUPLER | | | | | | | |
| QWNC1212FP | FB12-34NPT-F5 | 6WF6-B | 5100-S5-12 | 1543486 | WSC19-F-12N | F W6F6-B | VFF-12-12-C-NPT |
| QWNC1616FP | FB16-1NPT-F5 | 8WF8-B | 5100-S5-16 | 6125-16 | WSC25-F-16N | F W8F8-B | VFF-16-16-C-NPT |
| QWNC2020FP | FB20-114NPT-F5 | 10WF10-B | 5100-S5-20 | 6125-20 | WSC32-F-20N | F W10F10-B | VFF-20-20-C-NPT |
| QWNC2424FP | FB24-112NPT-F5 | 12WF12-B | 5100S5-24 | 6125-24 | WSC40-F-24N | F W12F12-B | VFF-24-24-C-NPT |
| WING NUT NIPPLE | | | | | | | |
| QWNN1212FP | FB12-34NPT-M5 | W6F6-B | 5100-S2-12 | 1536181 | WSC19-M-12N | M W6F6-B | VFF-12-12-N-NPT |
| QWNN1616FP | FB16-1NPT-M5 | W8F8-B | 5100-S2-16 | 6105-16 | WSC25-M-16N | M W8F8-B | VFF-16-16-N-NPT |
| QWNN2020FP | FB20-114NPT-M5 | W10F10-B | 5100-S2-20 | 6105-20 | WSC32-M-20N | M W10F10-B | VFF-20-20-N-NPT |
| QWNN2424FP | FB24-112NPT-M5 | W12F12-B | 5100-S2-24 | 6105-24 | WSC40-M-24N | M W12F12-B | VFF-24-24-N-NPT |
| HYDRAULIC JACK COUPLER | | | | | | | |
| QJC44MP-P | | 2TM2 | | 3050-2 | PSB06-F-04NM | F IVHP 1/4 NPT EST | PVS-04-04-C-NPT |
| QJC66MP-P | | 3TM3 | | 3050-3 | PSB10-F-06NM | F IVHP 3/8 NPT EST | PVS-06-06-C-NPT |
| HYDRAULIC JACK NIPPLE | | | | | | | |
| QJN44FP-P | | T2F2 | | 3010-2 | PSB06-M-04N | M IVHP 1/4 NPT | PVS-04-04-N-F-NPT |
| QJN66FP-P | | T3F3 | | 3010-3 | PSB10-M-06N | M IVHP 3/8 NPT | PVS-06-06-N-F-NPT |
| VV/VVS- SCREW TO CONNECT COUPLER | | | | | | | |
| QVC44FP | VV14NPTF | | | | PLC06-F-04N | | VV-04-04-C-NPT |
| QVC66FP | VV38NPTF | | | | PLC10-F-06N | | VV-06-06-C-NPT |
| QVC88FP | VV12NPTF | | | | PLC12-F-08N | | VV-08-08-C-NPT |
| QVC1212FP | VV34NPTF | | | | PLC19-F-12N | | VV-12-12-C-NPT |
| QVC1616FP | VV1NPTF | | | | PLC25-F-16N | | VV-16-16-C-NPT |
| VV/VVS- SCREW TO CONNECT NIPPLE | | | | | | | |
| QVN44FP | VV14NPTM | | | | PLC06-M-04N | | VV-04-04-M-NPT |
| QVN66FP | VV38NPTM | | | | PLC10-M-06N | | VV-06-06-M-NPT |
| QVN88FP | VV12NPTM | | | | PLC12-M-08N | | VV-08-08-M-NPT |
| QVN1212FP | VV34NPTM | | | | PLC19-M-12N | | VV-12-12-M-NPT |
| QVN1616FP | VV1NPTM | | | | PLC25-M-16N | | VV-16-16-M-NPT |
| DIAGNOSTIC COUPLER | | | | | | | |
| QTPC22FP | DF 04-18 NPT F | 1PDF1 | FD90-1021-02-04 | PD222 | | | |
| QTPC24FP | DF 04-14 NPT F | 1PDF2 | FD90-1021-04-04 | PD242 | | | D-04-04-C-F-NPT |
| QTPC24MP | DF 04-1/14 NPT F | 1PDM2 | | PD243 | | | D-04-04-C-M-NPT |
| QTPC24FOB | DF 04-14SAE F | | | | | | |
| QTPC26FOB | DF 04-38SAE F | | | | | | |

Hydraulic Quick Disconnect - Interchange Guide

| FORSAFLEX | FASTER | DIXON | AEROQUIP | PARKER | HOLMBURY | STUCCHI | DNP |
|----------------------------|-----------------|--------|-----------------|------------|-------------|---------------|-------------------|
| DIAGNOSTIC NIPPLE | | | | | | | |
| QTPN22FP | DF 04-18 NPT M | PD1F1 | FD90-1034-02-04 | PD322 | | | |
| QTPN24FP | DF 04-14 NPT M | PD1F2 | FD90-1034-04-04 | PD342 | | | D-04-04-N-F-NPT |
| QTPN22MP | DF04-1/18NPT M | PD1M1 | | PD323 | | | |
| QTPN24MP | DF 04-1/14NPT M | PD1M2 | FD90-1012-04-04 | PD343 | | | D-04-04-N-M-NPT |
| QTPN24MOB | DF 04-1/14SAE M | PD1OM2 | FD90-1044-04-04 | PD341 | | | D-04-04-N-M-SAE |
| QTPN26MOB | DF 04-1/38SAE M | PD1OM3 | FD90-1044-06-04 | PD361 | | | D-04-06-N-M-SAE |
| QTPN214MML | DF04-21/1415 M | | FD90-1046-06-04 | | | | |
| SNAP-TITE H COUPLER | | | | | | | |
| QHC44FP | TNV04NPTF | 2VF2 | | VHC-4-4F | HTN06-F-04N | | TNV-04-04-C-F-NPT |
| QHC66FP | TNV06NPTF | 3VF3 | | VHC-6-6F | HTN10-F-06N | | TNV-06-06-C-F-NPT |
| QHC88FP | TNV08NPTF | 4VF4 | | VHC-8-8F | HTN12-F-08N | | TNV-08-08-C-F-NPT |
| QHC1212FP | TNV12NPTF | 6VF6 | | VHC-12-12F | HTN19-F-12N | | TNV-12-12-C-F-NPT |
| QHC1616FP | TNV16NPTF | 8VF8 | | VHC-16-16F | HTN25-F-16N | | TNV-16-16-C-F-NPT |
| SNAP-TITE H NIPPLE | | | | | | | |
| QHN44FP | TNV04NPTM | V2F2 | | VHN-4-4F | HTN06-M-04N | | TNV-04-04-N-F-NPT |
| QHN66FP | TNV06NPTM | V3F3 | | VHN-6-6F | HTN10-M-06N | | TNV-06-06-N-F-NPT |
| QHN88FP | TNV08NPTM | V4F4 | | VHN-8-8F | HTN12-M-08N | | TNV-08-08-N-F-NPT |
| QHN1212FP | TNV12NPTM | V6F6 | | VHN-12-12F | HTN19-M-12N | | TNV-12-12-N-F-NPT |
| QHN1616FP | TNV16NPTM | V8F8 | | VHN-16-16F | HTN25-M-16N | | TNV-16-16-N-F-NPT |
| ISO-A COUPLER | | | | | | | |
| QAC44FP | ANV14NPTF | 2KF2 | 5601-4-4S | 04-04-6601 | IA06-F-04N | F BIR 14 NPT | ANV-04-04-C-NPT |
| QAC66FP | ANV38NPTF | 3KF3 | 5601-6-6S | 06-06-6601 | IA10-F-06N | F BIR 38 NPT | ANV-06-06-C-NPT |
| QAC1212FP | ANV34NPTF | 6KF6 | 5601-12-12S | 12-12-6601 | IA19-F-12N | F BIR 34 NPT | ANV-12-12-C-NPT |
| QAC1616FP | ANV1NPTF | 8KF8 | 5601-16-16S | 6601-16-16 | IA25-F-16N | F BIR 100 NPT | ANV-16-16-C-NPT |
| ISO-A NIPPLE | | | | | | | |
| QAN44FP | ANV14NPTM | K2F2 | 5602-4-4S | 04-04-6602 | IA06-M-04N | M BIR 14 NPT | ANV-04-04-N-NPT |
| QAN66FP | ANV38NPTM | K3F3 | 5602-6-6S | 06-06-6602 | IA10-M-06N | M BIR 38 NPT | ANV-06-06-N-NPT |
| QAN1212FP | ANV34NPTM | K6F6 | 5602-12-12S | 12-12-6602 | IA19-M-12N | M BIR 34 NPT | ANV-12-12-N-NPT |
| QAN1616FP | ANV1NPTM | K8F8 | 5602-16-16S | 6602-16-16 | IA25-M-16N | M BIR 100 NPT | ANV-16-16-N-NPT |

Hydraulic Quick Disconnect - Interchange Guide

| FORSAFLEX | FASTER | DIXON | AEROQUIP | PARKER | HOLMBURY | STUCCHI | DNP |
|----------------------|------------|---------|-----------------|---------|-------------|----------------|------------------------|
| ISO-B COUPLER | | | | | | | |
| QBC22FP | HN18NPTF | 1HF1 | FD45-1003-02-02 | H2-61 | IB04-F-02N | F IRB 18 NPT | HN18-02-02-C-NPT |
| QBC44FP | HN14NPTF | 2HF2 | FD45-1003-04-04 | H2-62 | IB06-F-04N | F IRB 14 NPT | HN14-04-04-C-NPT |
| QBC66FP | HN38NPTF | 3HF3 | FD45-1003-06-06 | H3-62 | IB10-F-06N | F IRB 38 NPT | HN38-06-06-C-NPT |
| QBC88FP | HN12NPTF | 4HF4 | FD45-1003-08-10 | H4-62 | IB12-F-08N | F IRB 12 NPT | HN12-08-08-C-NPT |
| QBC1212FP | HN34NPTF | 6HF6 | FD45-1003-12-12 | H6-62 | IB19-F-12N | F IRB 34 NPT | HN34-12-12-C-NPT |
| QBC1616FP | HN1NPTF | 8HF8 | FD45-1003-16-16 | H8-62 | IB25-F-16N | F IRB 100 NPT | HN16-16-16-C-NPT |
| QBC2424FP | HN112NPTF | 12HF12 | | H12-62N | | | |
| QBC44FP-BR | HN14NPTF5 | 2HF2B | FD45-1101-04-04 | BH2-60 | IBB06-F-04N | F IRBOV14 NPT | HN14-B-04-04-C-NPT |
| QBC66FP-BR | HN38NPTF5 | 3HF3B | FD45-1101-06-06 | BH3-60 | IBB10-F-06N | F IRBOV38 NPT | HN38-B-06-06-C-NPT |
| QBC88FP-BR | HN12NPTF5 | 4HF4B | FD45-1101-08-10 | BH4-60 | IBB12-F-08N | F IRBOV12 NPT | HN12-B-08-08-C-NPT |
| QBC1212FP-BR | HN34NPTF5 | 6HF6B | FD45-1101-12-12 | BH6-60 | IBB19-F-12N | F IRBOV34 NPT | HN34-B-12-12-C-NPT |
| QBC1616FP-BR | HN1NPTF5 | 8HF8B | FD45-1101-16-16 | BH8-60 | IBB25-F-16N | F IRBOV100 NPT | HN16-B-16-16-C-NPT |
| QBC44FP-SS | HN14NPTF2V | 2HF2-SS | FD45-1076-04-04 | SH2-62 | IBS06-F-04N | F IRBXV14 NPT | HN14-SS316-04-04-C-NPT |
| QBC66FP-SS | HN38NPTF2V | 3HF3-SS | FD45-1076-06-06 | SH3-62 | IBS10-F-06N | F IRBXV38 NPT | HN38-SS316-06-06-C-NPT |
| QBC88FP-SS | HN12NPTF2V | 4HF4-SS | FD45-1076-08-10 | SH4-62 | IBS12-F-08N | F IRBXV12 NPT | HN12-SS316-08-08-C-NPT |
| QBC1212FP-SS | HN34NPTF2V | 6HF6-SS | FD45-1076-12-12 | SH6-62 | IBS19-F-12N | F IRBXV34 NPT | HN34-SS316-12-12-C-NPT |
| QBC1616FP-SS | HN1NPTF2V | 8HF8-SS | FD45-1076-16-16 | SH8-62 | IBS25-F-16N | F IRBXV100 NPT | HN16-SS316-16-16-C-NPT |

* Forsaflex standard stainless steel is 304. (316 stainless is available on special request)

Hydraulic Quick Disconnect - Interchange Guide

| FORSAFLEX | FASTER | DIXON | AEROQUIP | PARKER | HOLMBURY | STUCCHI | DNP |
|--|-------------|---------|-----------------|---------|-------------|----------------|-----------------------|
| ISO-B NIPPLE | | | | | | | |
| QBN22FP | HNV18NPTM | H1F1 | FD45-1002-02-02 | H1-63 | IB04-M-02N | M IRB 18 NPT | HNV-02-02-N-NPT |
| QBN44FP | HNV14NPTM | H2F2 | FD45-1002-04-04 | H2-63 | IB06-M-04N | M IRB 14 NPT | HNV-04-04-N-NPT |
| QBN66FP | HNV38NPTM | H3F3 | FD45-1002-06-06 | H3-63 | IB10-M-06N | M IRB 38 NPT | HNV-06-06-N-NPT |
| QBN88FP | HNV12NPTM | H4F4 | FD45-1002-08-10 | H4-63 | IB12-M-08N | M IRB 12 NPT | HNV-08-08-N-NPT |
| QBN1212FP | HNV34NPTM | H6F6 | FD45-1002-12-12 | H6-63 | IB19-M-12N | M IRB 34 NPT | HNV-12-12-C-NPT |
| QBN1616FP | HNV1NPTM | H8F8 | FD45-1002-16-16 | H8-63 | IB25-M-16N | M IRB 100 NPT | HNV-16-16-N-NPT |
| QBN2424FP | HNV112NPTM | H12F12 | | H12-63N | | | |
| QBN88FP-BR | HNV14NPTM5 | H2F2-B | FD45-1086-04-04 | BH2-61 | IBB06-M-04N | M IRBOV-14 NPT | HNV-B-04-04-N-NPT |
| QBN66FP-BR | HNV38NPTM5 | H3F3-B | FD45-1086-06-06 | BH3-61 | IBB10-M-06N | M IRBOV38 NPT | HNV-B-06-06-N-NPT |
| QBN88FP-BR | HNV12NPTM5 | H4F4-B | FD45-1086-08-10 | BH4-61 | IBB12-M-08N | M IRBOV12 NPT | HNV-B-08-08-N-NPT |
| QBN1212FP-BR | HNV34NPTM5 | H6F6-B | FD45-1086-12-12 | BH6-61 | IBB19-M-12N | M IRBOV34 NPT | HNV-B-12-12-C-NPT |
| QBN1616FP-BR | HNV1NPTM5 | H8F8-B | FD45-1086-16-16 | BH8-61 | IBB25-M-16N | M IRBOV100 NPT | HNV-B-16-16-N-NPT |
| QBN44FP-SS | HNV14NPTM2V | H2F2-SS | FD45-1078-04-04 | SH2-63 | IBS06-M-04N | M IRBOV14 NPT | HNV-SS316-04-04-N-NPT |
| QBN66FP-SS | HNV38NPTM2V | H3F3-SS | FD45-1078-06-06 | SH3-63 | IBS10-M-06N | M IRBOV38 NPT | HNV-SS316-06-06-N-NPT |
| QBN66FP-SS | HNV38NPTM2V | H4F4-SS | FD45-1078-08-10 | SH4-63 | IBS12-M-08N | M IRBOV12 NPT | HNV-SS316-08-08-N-NPT |
| QBN66FP-SS | HNV38NPTM2V | H6F6-SS | FD45-1078-12-12 | SH6-63 | IBS19-M-12N | M IRBOV34 NPT | HNV-SS316-12-12-C-NPT |
| QBN66FP-SS | HNV38NPTM2V | H8F8-SS | FD45-1078-16-16 | SH8-63 | IBS25-M-16N | M IRBOV100 NPT | HNV-SS316-16-16-N-NPT |
| * Forsaflex standard stainless steel is 304. (316 stainless is available on special request) | | | | | | | |

Hydraulic Quick Disconnect - Interchange Guide

| FORSAFLEX | FASTER | DIXON | AEROQUIP | PARKER | HOLMBURY | STUCCHI | DNP |
|---------------------------------|--------|--------|----------|---------|----------|---------|-----|
| STRAIGHT THROUGH COUPLER | | | | | | | |
| QSTC22FP | | 1EF1 | | SST-1M | | | |
| QSTC44FP | | 2EF2 | | SST-2M | | | |
| QSTC66FP | | 3EF3 | | SST-3M | | | |
| QSTC88FP | | 4EF4 | | SST-4M | | | |
| QSTC1212FP | | 6EF6 | | SST-6M | | | |
| QSTC1616FP | | 8EF8 | | SST-8M | | | |
| QSTC22MP | | 1EM1 | | SST-1 | | | |
| QSTC44MP | | 2EM2 | | SST-2 | | | |
| QSTC66MP | | 3EM3 | | SST-3 | | | |
| QSTC88MP | | 4EM4 | | SST-4 | | | |
| QSTC1212MP | | 6EM6 | | SST-5 | | | |
| QSTC1616MP | | 8EM8 | | SST-6 | | | |
| STRAIGHT THROUGH NIPPLE | | | | | | | |
| QSTN22FP-SS | | E1F1-S | | SST-N1 | | | |
| QSTN44FP-SS | | E2F2-S | | SST-N2 | | | |
| QSTN66FP-SS | | E3F3-S | | SST-N3 | | | |
| QSTN88FP-SS | | E4F4-S | | SST-N4 | | | |
| QSTN1212FP-SS | | E6F6-S | | SST-N6 | | | |
| QSTN1616FP-SS | | E8F8-S | | SST-N8 | | | |
| QSTN22MP-SS | | E1M1-S | | SST-N1M | | | |
| QSTN44MP-SS | | E2M2-S | | SST-N2M | | | |
| QSTN66MP-SS | | E3M3-S | | SST-N3M | | | |
| QSTN88MP-SS | | E4M4-S | | SST-N4M | | | |
| QSTN1212MP-SS | | E6M6-S | | SST-N6M | | | |
| QSTN1616MP-SS | | E8M8-S | | SST-N8M | | | |

